



CADS Revit to SCIA Engineer Help



GLOBAL CONSTRUCTION
SOFTWARE AND SERVICES



Microsoft
Partner

Contents

1	Introduction	1
1.1	BIM and the Structural/Analytical Model	1
2	Bi-directional link – Revit and SCIA Engineer	3
2.1	Items supported in the program:.....	3
2.2	Items not supported in the program:	4
2.3	Structural usage support:.....	4
3	Analytical model in Revit.....	5
3.1	Derived Analytical model:	5
3.2	Contextual Analytical model:	5
3.3	Creating analytical elements in Revit.....	5
3.4	Derived vs Contextual analytical model:.....	6
4	User interface and commands	7
4.1	Export to SCIA Engineer	7
4.2	Import SCIA Engineer model into Revit	8
4.3	Options.....	9
4.4	Node format.....	17
4.5	Export.....	18
4.6	Review and export	18
4.7	Show Unexported	20
4.8	Review and Import.....	20
4.9	Import	21
4.10	Select Imported.....	21
4.11	Mapping tables	22
4.12	Getting started	23
4.13	Best practices	23
4.14	Help	23
4.15	Check list	23
4.16	About.....	23
5	Mapping Tables.....	25
5.1	Mapping Tables from Ribbon.....	25
5.1.1	Mapping database	26
5.1.2	Document mapping.....	26
5.1.3	Save and Delete database.....	33

5.1.4	Import/Export database.....	33
5.2	Mapping tables from Options dialog	34
5.3	User Table	35
5.3.1	Adding mapping entries into User Table	36
5.3.2	Delete entries from User Table.....	37
5.4	Mapping during Export/Import.....	38
5.4.1	User mapping during Export (Revit – SCIA Engineer):	38
5.4.2	User mapping during Import (SCIA Engineer - Revit):.....	38
6	Import analysis results from SCIA Engineer	41
6.1.1	Co-ordinate system:.....	41
6.1.2	Importing analysis results	41
6.1.3	Viewing the analysis results	42
6.2	Beam reactions	45
6.3	Importing Design info from SCIA Engineer	47
7	Round trip	48
7.1	Step 1 – Create the model in Revit	48
7.2	Step 2 – Export to SCIA Engineer	49
7.3	Step 3 – Analyse / Design in SCIA Engineer	49
7.4	Step 4 – Update from SCIA Engineer	51
8	Features matrix for Revit link (Appendix)	52
9	Technical Support	61

1 Introduction

Revit is well known for Building information modelling (BIM) and SCIA Engineer for structural information modelling (also for Finite Element Method (FEM) analysis and design). This section explains the overall concept of the link between these two programs.

1.1 BIM and the Structural/Analytical Model

The picture below explains the high-level flow between the BIM and a typical structural analysis software.

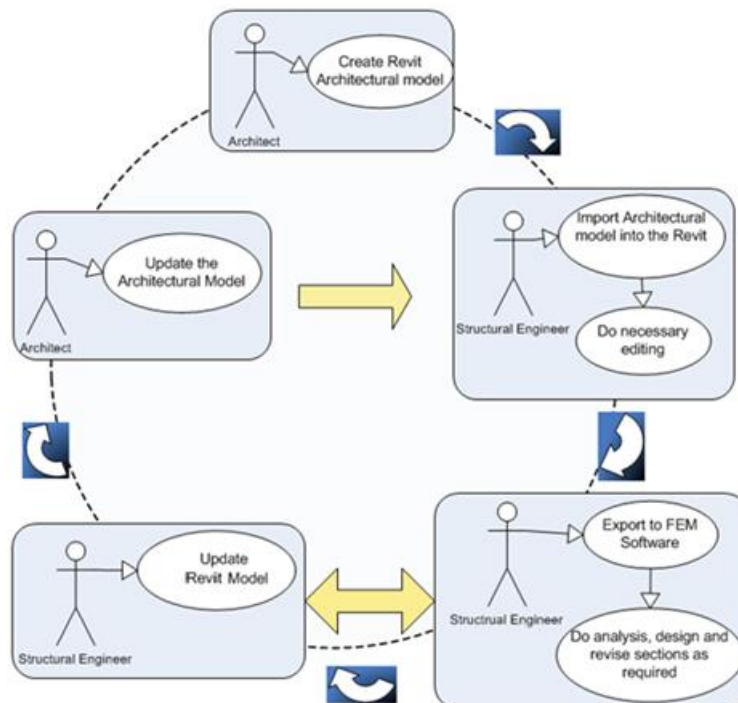

The Architect creates the architectural model in Revit (or imports it into Revit having created it in some other application) without having to be concerned about the structural aspects. When the architectural model is complete, it is passed to the structural engineer. The structural engineer updates the Revit model and modifies it from a structural point of view. You generate the analytical model (also known as the mathematical model or FEM model) as shown in the example below.

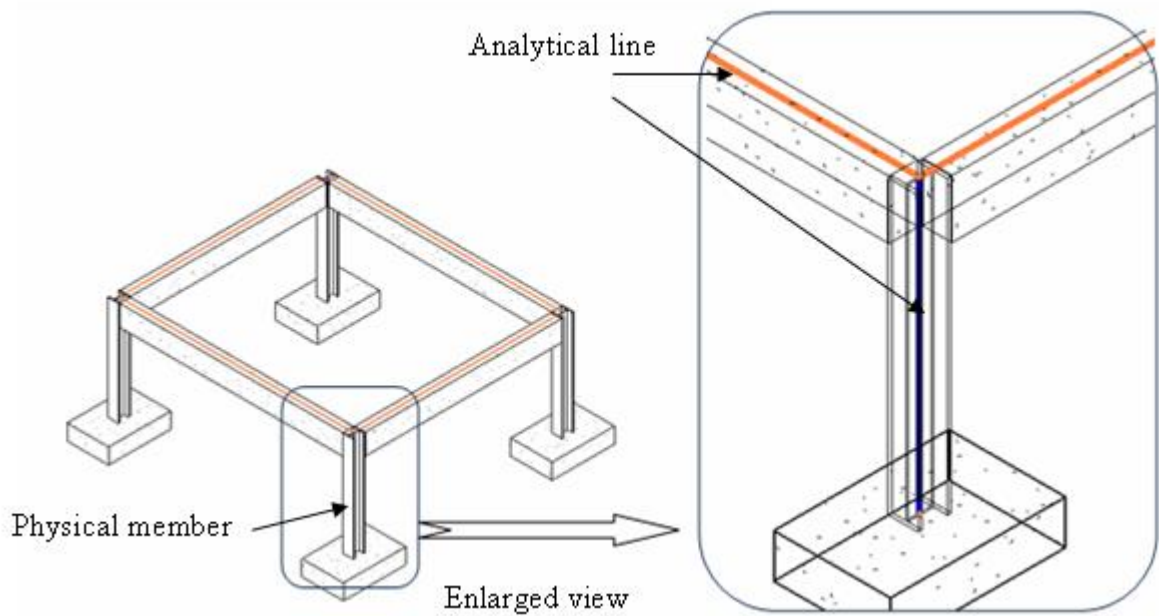

Revit model showing the physical member

Analytical lines of the member

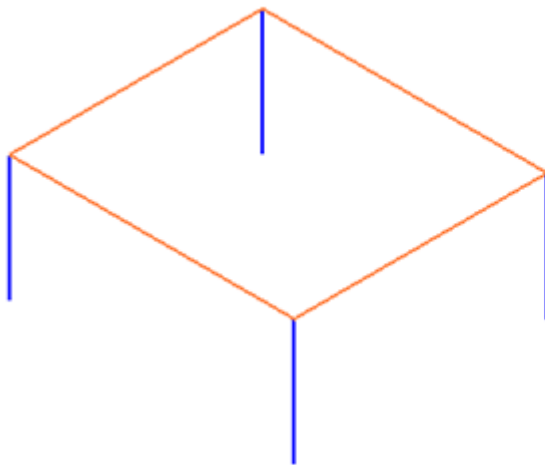

Revit Model – Analytical model view

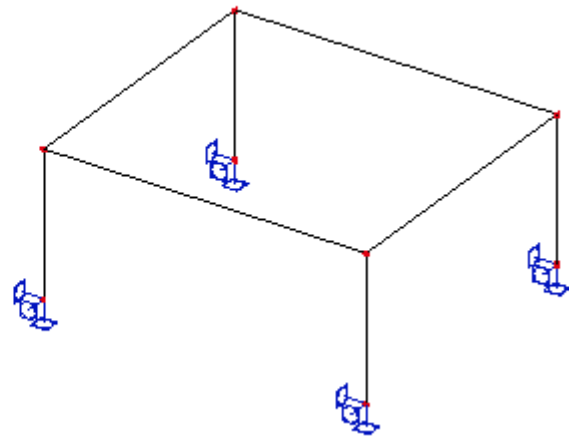

Exported Model in SCIA Engineer

The analytical model from Revit is transformed into a finite element model inside SCIA Engineer.

Note: In Revit 2023, the analytical model feature has been modified significantly. The approach for generating the analytical model is now changed from “Derived analytical model” to “Contextual analytical model”. For more details about Structural analytical modelling in Revit, please visit [Help | Structural Analytical Modeling for BIM Coordination | Autodesk](#).

2 Bi-directional link – Revit and SCIA Engineer

This link software supports a bi-directional link between Revit and SCIA Engineer.

2.1 Items supported in the program:

	Item in Revit	Item in SCIA Engineer
1	Structural Columns	Column (1D member)
2	Structural Framing: Beam	1D member
3	Structural Trusses	1D members
4	Structural Framing: Brace	1D member
5	Structural Beam system	1D members
6	Wall: Structural	2D member
7	Floor: Structural	2D member
8	Analytical Members	1D members
9	Analytical Panels	2D members/Load panels
10	Holes in slab or wall	Openings in 2D member
11	Openings in analytical panel	Openings in 2D member/Openings in Load panels
11	Holes in Beam web	Openings in 1D member
12	Structural Foundation: Wall	Fixed line support
13	Structural Foundation: Slab	2D Element/Slab + subsoil/Line or point support depending on structural element supported
14	Boundary Conditions	Support
15	Free point load*	Free point load
16	Free line load*	Line force/Line moment
17	Area load*	Patch load
18	Hosted Point load	Point force/Point moment (Node/Member)
19	Hosted Line load	Line force/Line moment (Uniform/Varying and Full/Partial)
20	Hosted Area load	Surface force on 2D member (Uniform and Full/Patch)
21	Load cases with load nature "dead", "live", "wind" etc.	Load cases with load groups using appropriate load type
22	Load Combinations	Load combinations
23	Grouped Revit Structure objects	None
24	User defined families for Frames and Columns	Cross sections according to user mapping / General cross sections.
25	Composite floor	Composite slab
26	Floor with metal deck	Metal deck
27	Levels	Stories (only from SCIA Engineer to Revit)

28	Structural Area Reinforcement	2D Reinforcement (only from SCIA Engineer to Revit)
29	Reinforcement in frames and columns	Reinforcement. (When exported from Revit to SCIA Engineer it is exported as PRAD reinforcement.)
30	Analytical link	Rigid arm

*Only for Revit 2023. In Revit 2024, it is not possible to create loads without a host.

2.2 Items not supported in the program:

	Item in Revit	Item in SCIA Engineer
1	None	Shell
2	User defined family forming more than one profile	None
3	1D Grid	None
4	Web stiffeners	Web Stiffeners

2.3 Structural usage support:

Revit classifies its structural elements based on the function of the member but SCIA uses a different naming convention for the “Member type” property. The following table lists the mapping between SCIA Engineer and Revit:

	Item in SCIA Engineer	Item in Revit
1	Member type = Column	Structural Columns / Analytical Members
2	Member type = Beam	Structural Framing – Beam / Analytical Members
3	Member type = Wall Bracing	Structural Framing -Vertical Bracing / Analytical Members
4	Member type = Roof Bracing	Structural Framing - Horizontal Bracing / Analytical Members
5	Member type = General	Inferred based on direction of member

3 Analytical model in Revit

3.1 Derived Analytical model:

Revit used this method until the version 2022 to handle analytical elements. The analytical model is a special representation of the physical model with additional information required for structural calculations. This could be turned on or off from the Enable Analytical Model option.

Once the analytical element is turned on, properties that are relevant for structural analysis and design, like boundary conditions, end fixities (hinges), member end forces and loads can be assigned to the analytical model.

Revit link relies heavily on this analytical model and works by reading all the properties from this analytical model and sending it to SCIA Engineer.

3.2 Contextual Analytical model:

Revit 2023 shifts to a new system called the Contextual analytical model. A new class of structural elements are introduced that are no longer derived from or necessarily coupled to the physical elements. Instead, it is now possible to create analytical elements independent of the physical member, or even in the absence of one. Once an analytical element is created, it can be associated to any physical member but it is not essential.

Some properties that were earlier a part of only the physical member (like materials, cross sections, etc.) can now be associated with the analytical member too.

3.3 Creating analytical elements in Revit

When a physical model is present, you can use the Analytical automation tool to generate analytical elements from physical members.

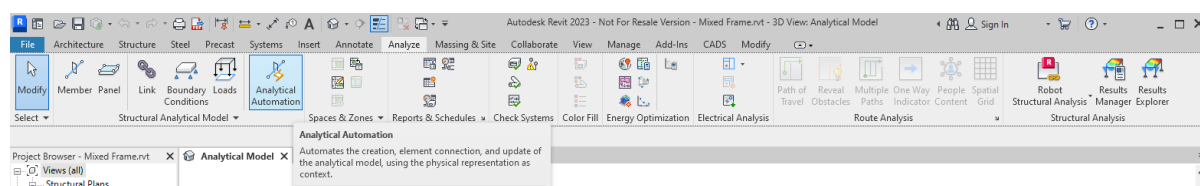

This tool is a Dynamo script, which generates the analytical elements from the physical model and vice versa.

Alternatively, individual analytical elements may be created by using the Analytical member or Analytical panel command. Once created these elements may be associated with physical members, or left as they are without any association with a physical member.

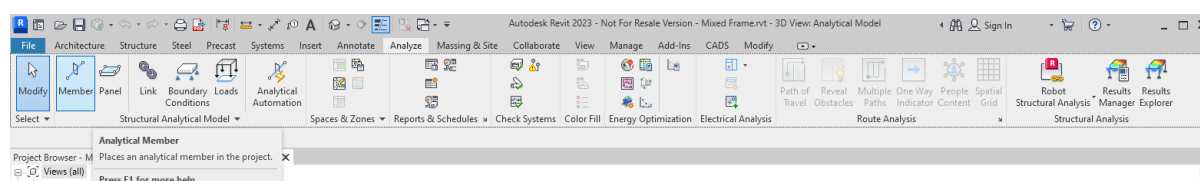

In Revit 2024, you can have custom association which enables you to associate multiple analytical panels or members to a single structural object or vice versa. For more details about physical - analytical element association in Revit, please visit [Help | Custom Physical-Analytical Element Association | Autodesk](#).

3.4 Derived vs Contextual analytical model:

	Derived analytical model	Contextual analytical model
Analytical member	Analytical model is created from physical elements. It is enabled by setting the option "Enable analytical model" to true.	Analytical model can be created separately. Analytical automation tool developed in dynamo can be used to generate the analytical model.
Association with physical model	Coupled with physical model. Analytical model cannot exist without physical model.	Analytical model can exist independently and may or may not be associated with a physical model.
Geometry	Some properties like position, size, etc. are different from the physical model.	Can be completely Independent of physical model.
Cross-section	Uses the same cross-section as physical model	Independent of physical model.
Material	Uses the same material as physical model	Independent of physical model.
Eccentricities	Eccentricities are referenced from the position of the physical member.	-NA-
Other properties – Camber size, Number of studs	Read from physical model	-NA-

4 User interface and commands

CADS Revit SCIA Engineer Link is available in the main Revit ribbon under then **CADS** ribbon group

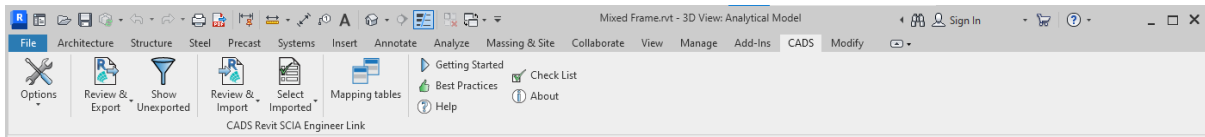

4.1 Export to SCIA Engineer

This section explains how a Revit model can be exported into SCIA Engineer.

It is recommended to use the “structural template” for creating the Revit model. If you work with the Eurocode, then you should select the appropriate Eurocode template as illustrated below.

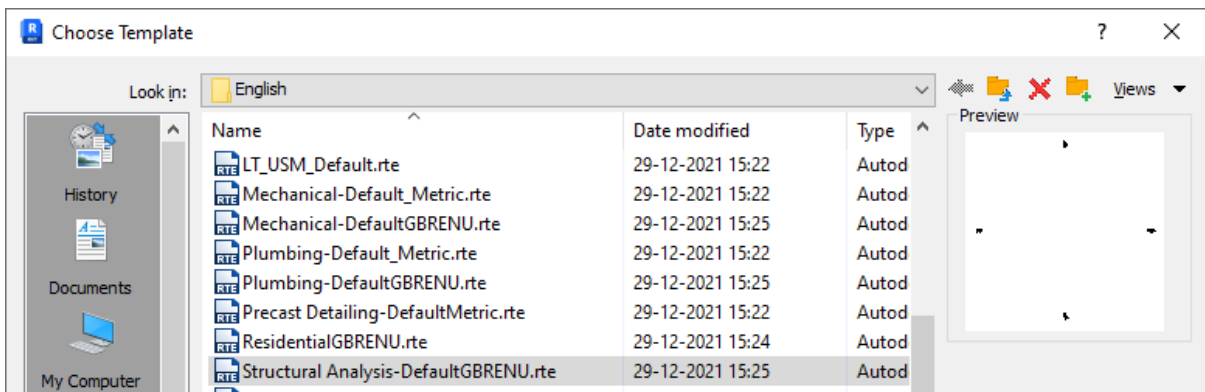

The screenshot below is an example of a model created using Revit.

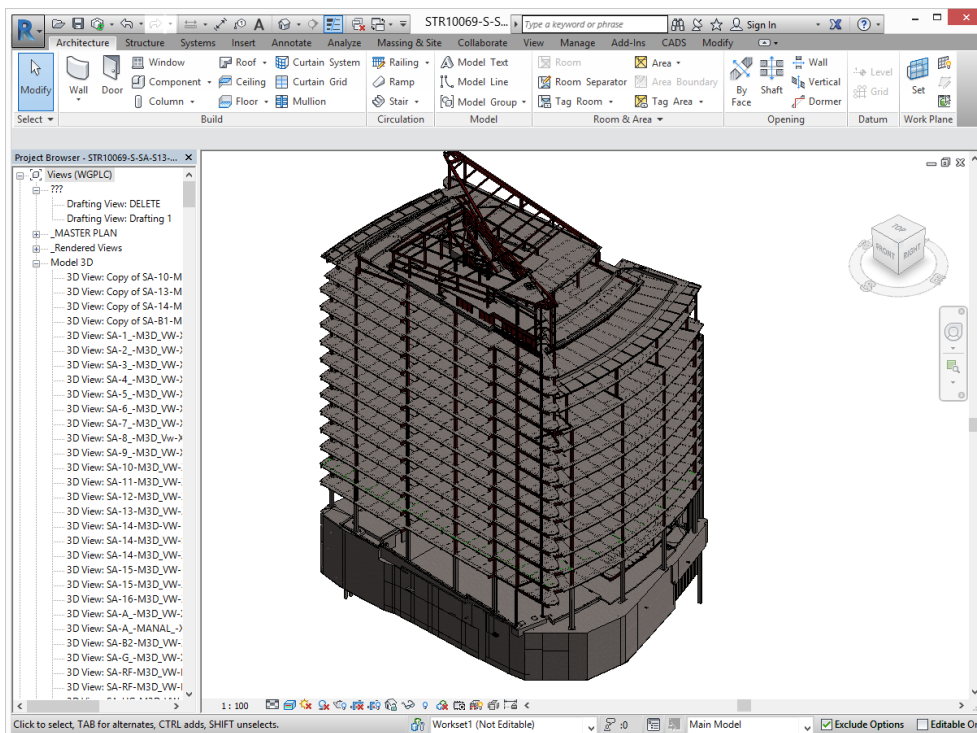

Once the project is created, it has to be saved before exporting into SCIA Engineer. The program will prompt with the *file save dialog* if the project has not already been saved.

There are two ways you could initiate the export of a Revit structural model to SCIA Engineer.

The first is,

R Revit -> CADS -> CADS Revit SCIA Engineer Link -> Options-> Export to SCIA Engineer

The second option is to use the *Review & Export / Export* option.

R Revit -> CADS -> CADS Revit SCIA Engineer Link -> Export

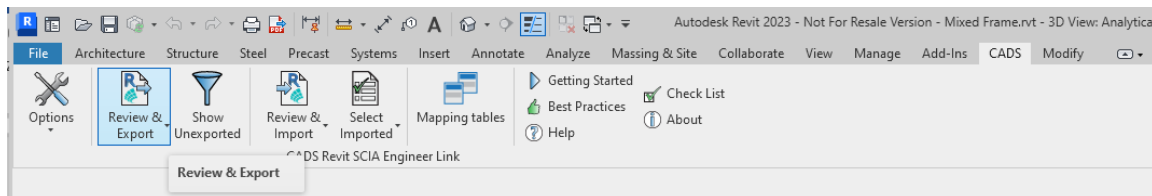

This option allows the export of the Revit model into SCIA Engineer using the current user options.

The picture below shows the exported SCIA Engineer model for the previous Revit example.

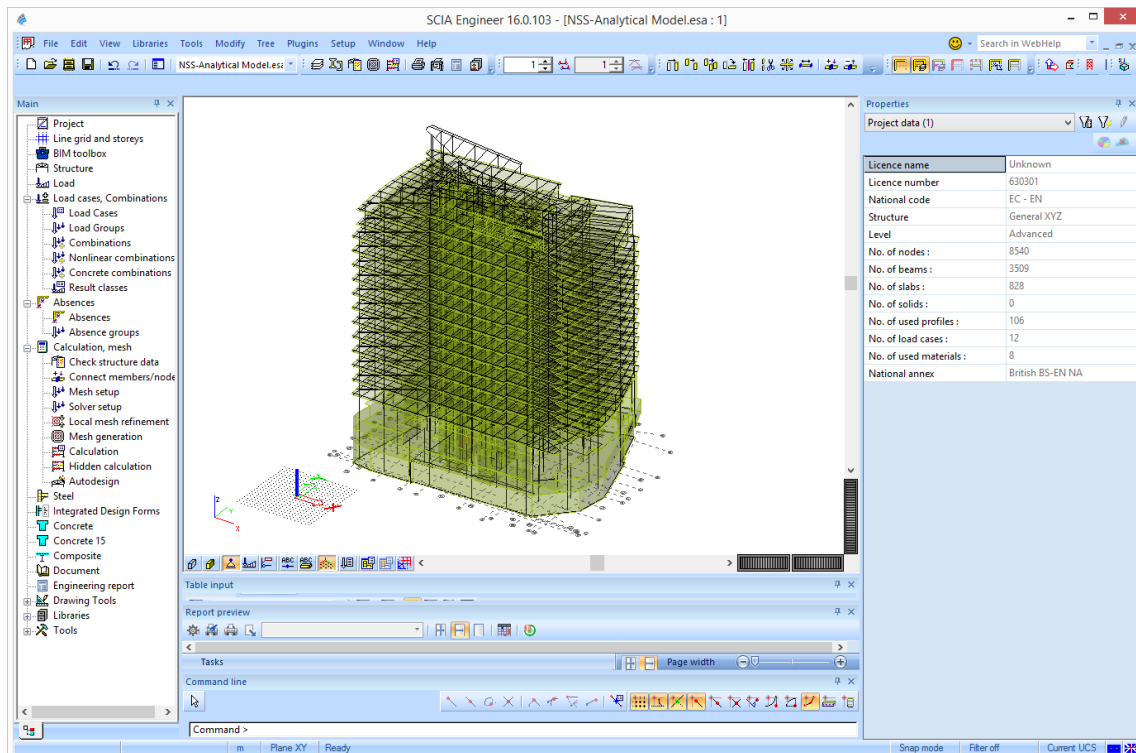

4.2 Import SCIA Engineer model into Revit

This section explains how a model in SCIA Engineer model can be imported into Revit. Before you start the import of the model from SCIA Engineer, you need to create a blank Revit document using the “Structural template”. Choose the structural template from the standard Revit templates according to the National code.

The Revit project has to be saved before importing the SCIA Engineer model. The program prompts you to save the file if the project has not already been saved.

You can import a SCIA Engineer model into Revit using the *Review & Import / Import* option.

There are two ways you could import a SCIA Engineer model into Revit: Direct exchange and File exchange.

If you have chosen “Direct exchange”, the model currently open in SCIA Engineer will be imported into Revit.

R Revit -> CADs -> Revit SCIA Engineer Link -> Import

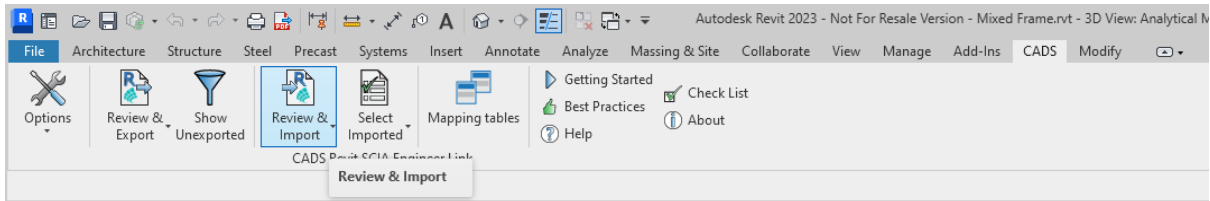

In order to use the “file exchange” method, you will need to export the SCIA Engineer to an .r2s file format first. This could be done from inside SCIA Engineer by choosing File -> Export -> Revit file. Once this file is saved you will need to choose the below option:

R Revit -> CADs -> CADs Revit SCIA Engineer Link -> Options-> Import from SCIA Engineer

You will be prompted to select the .r2s file which you created and the model from the selected file will be imported into Revit.

In both kinds of exchange, the details of the members imported, warnings and errors if any will be listed in the log file.

4.3 Options

The following dialog is displayed when the “Options” command has been selected from the toolbar.

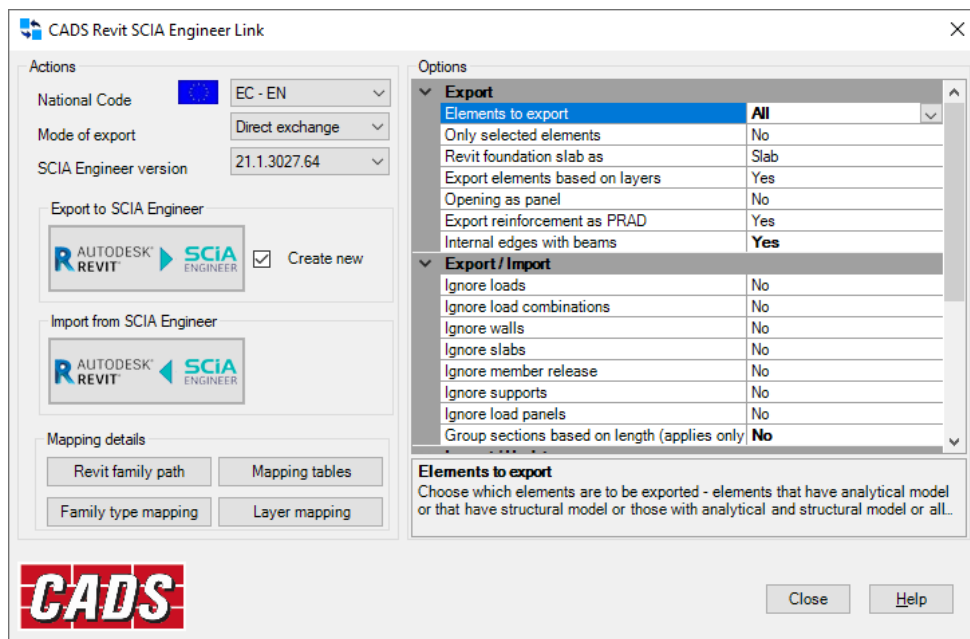
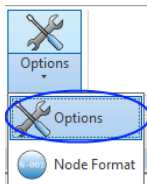

Actions

National code

The national code option specifies which National Code is to be used in SCIA Engineer.

The following National Codes are supported:

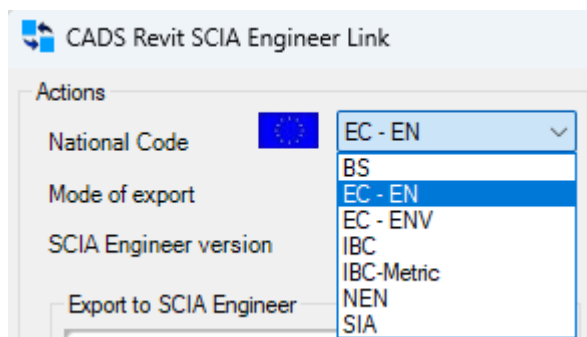

Note:

The material mapping is dependent on the National Code and hence it is important to select the correct National Code.

The link program does not validate the national code used in the Revit template and the national code selected in the Options dialog. Hence it is important that you chose the correct national code. For example, if you have modelled using the Canadian template and tries to export using the EC-EN national code, the program may not work as expected.

Mode of Export

The Mode of Export can be set in this dialog.

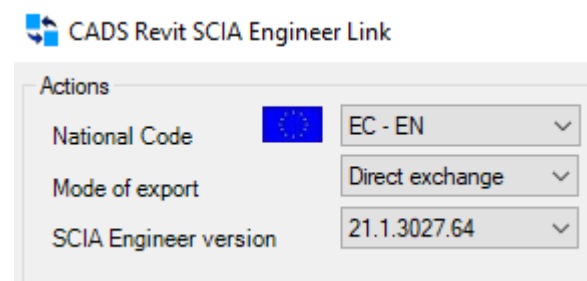

These options work differently depending on the context in which they are used.

If the model is exported from Revit, the option “Mode of Export = Direct Exchange” launches SCIA Engineer and exports the model into it.

When importing from SCIA Engineer, the option “Direct Exchange” reads the active SCIA Engineer job and updates the current Revit model.

The option “Mode of Export = File Exchange” writes the analytical model data as a SCIA Engineer Revit file (e.g. model.R2S) which can be opened/imported into SCIA Engineer using the command “Import → Revit File.”

Note:

The File Exchange option does not require SCIA Engineer to be installed in the computer and allows the sending of this file to other users who have the full version of SCIA Engineer installed.

Export to SCIA Engineer

Selecting “Export to SCIA Engineer” exports the Revit model into SCIA Engineer. Selecting the “Import from SCIA Engineer” imports the SCIA Engineer model into Revit or updates the Revit model from SCIA Engineer.



Create New

By default, the “Export to SCIA Engineer” will update if any existing SCIA Engineer file with the same name is available in the folder.

If you select “Create New”, then the existing SCIA Engineer file with the same name in the folder is deleted and a new SCIA Engineer file is created (if it is not already opened in SCIA Engineer). If it is already opened in SCIA Engineer, it cannot overwrite the file and a warning message is being displayed.

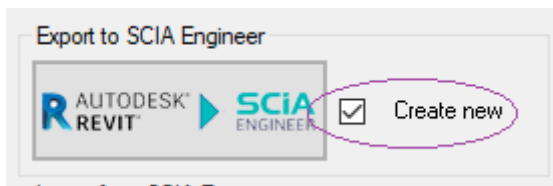

Options and filters

Filtering options allow you to ignore certain items so they are not exported from Revit.

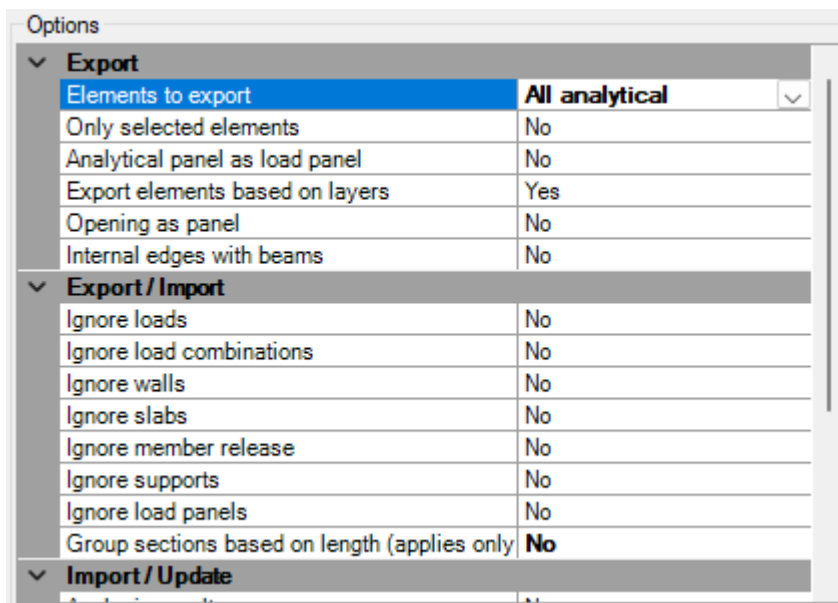

Export

Elements to export: This option allows you to specify the type of elements to export to SCIA Engineer. The options available are:

- All analytical – All analytical elements are exported to SCIA Engineer irrespective its association with the structural model. The elements will be exported to SCIA Engineer based only on the analytical member properties. Boundary conditions, member end fixities, and loads if defined in Revit will be exported. If this option is selected, the link will not read any structural elements or properties from structural member.
- All structural - All structural elements are exported to SCIA Engineer irrespective its association with the analytical model. The elements will be exported to SCIA Engineer based only on the structural member properties. Boundary conditions, member end fixities, and loads if defined in Revit will not be exported. If this option is selected, the link will not read any analytical elements.
- With both analytical and structural – The structural members which are associated to the analytical members are only exported to SCIA Engineer. If this option is selected, the link will not export the members with only structural or analytical elements. The geometry of members and the properties like material, cross-section and section rotation will be read from analytical model and the additional properties like alignment, composite deck info is read from structural properties. Boundary conditions, member end fixities, and loads if defined in Revit will be exported.
- All - All elements in Revit are exported to SCIA Engineer. If the structural members are associated with analytical members, the properties of analytical model will take the precedence.

Please note that, the option specified during export will become read-only after successful export. To change the option, you have to export the model by setting the option “Create New” to true.

Only selected elements - This option allows you to export only the selected members from Revit to SCIA Engineer. This selection filter is applied based on the option chosen in “Elements to export” option.

Foundation slabs will be exported as specified. The “Default” option exports foundation slabs as set in the Revit properties. This option will not be available if the “Elements to Export” option is set as “All analytical”.

Export elements based on layers – If this option is set to “Yes”, the elements will be exported to SCIA Engineer in different layers based on their category and the layer mapping. The category includes the frames, columns, plates and walls and you could specify the layer names for each of these types.

Setting this option “No” will export all the elements into the default layer in SCIA Engineer. In the roundtrip, if you would like to retain the layer info for the models imported from SCIA Engineer, set this option to “No”.

Analytical panel as panel – Setting this option “yes” and “Ignore load panels” to “No” will export the analytical panels with structural role “Panel” as “Load panels”. If this option is set to “No”, the panels will be exported as slabs/walls based on its structural role. This option will not be available if the “Elements to Export” option is set as “All structural”.

Openings as panel – Setting this option “yes” will export the openings in slabs as “Panels in slabs”. If this option is set to “No”, the openings will be exported as openings.

Export reinforcement as PRAD – If this option is set to “Yes”, the reinforcements modelled in 1D members will be exported to SCIA Engineer as “PRAD” reinforcement. Beams with rectangle, T and L

cross-sections and columns with rectangle and circular sections are supported. If you don't need the reinforcements to be exported, set this option to "No". This option will not be available if the "Elements to Export" option is set as "All analytical".

If the "Internal edges with beams" is set to "Yes", internal edges in the SCIA Engineer model will be created for slabs at beam locations.

Export / Import

Ignore loads - If this option is set to "Yes", the loads are not considered for both export and import. This option will not be available if the "Elements to Export" option is set as "All structural".

Ignore load combinations – If this option is set to "Yes", the loads combinations are not considered for both export and import. This option will be available only if the option "Ignore loads" is set to "False".

Ignore walls - If this option is set to "Yes", walls are not considered for both export and import.

Ignore slabs - If this option is set to "Yes", structural slabs are not considered for both export and import.

Ignore member release - If this option is set to "Yes", member end releases are not considered for both export and import. This option will not be available if the "Elements to Export" option is set as "All structural".

Ignore supports - If this option is set to "Yes", the Boundary conditions are not considered for both export and import. This option will not be available if the "Elements to Export" option is set as "All structural".

Ignore load panels – If this option is set to "Yes", the load panels are not considered for both export and import.

Group sections based on length – If this option is set to "All sections", the families are grouped based on their length. During export, for each group, a section is created in SCIA Engineer. If this option is set to "Circular hollow sections only", the families with section shape "circular hollow sections" are grouped based on their length. By default, the option is set to "No".

This option is applicable only for families with steel materials. This option is primarily intended to be used in the export/import of scaffold models (where members of the same cross section may need to be grouped based on their length).

If the option "Ignore loads" and "Ignore load combinations" are both set to "Yes", and the option "Analysis Results" is set to "No", the loads cases too will not be imported. In all other cases, the load cases will be automatically imported as the load cases will be required for load combinations and analysis results.

Import / Update

Import / Update	
Type of members to create in Revit	Both structural and an
Analysis results	Yes
Ignore generated loads on load panels	Yes
Ignore reinforcement	No
Create levels	Based on storey
Update reinforcement geometry	No
Update 2D member openings	Yes
Update member size only	Yes
Update elevation of level based on storey	No

Type of members to create in Revit - This option allows you to specify the type of members to create in Revit. The options available are:

- Analytical – The application will create only the analytical elements in Revit. The properties like eccentricity, composite deck info may be lost as the Revit analytical members doesn't have these properties. Boundary conditions, member end fixities, and loads if defined in SCIA Engineer will be imported. If this option is selected, the link will not create structural elements in Revit.
- Structural - The application will create only the structural elements in Revit. Boundary conditions, member end fixities, and loads if defined in SCIA Engineer will not be imported. If this option is selected, the link will not create analytical elements in Revit.
- Both structural and analytical - The application will create both structural and analytical elements in Revit. The structural elements and the analytical elements will be associated automatically. The properties like eccentricity, composite deck info are applied to the structural members. Boundary conditions, member end fixities, and loads if defined in SCIA Engineer will be imported.

Please note, this option will not be available in the update process.

Analysis Results – If this option is set to “Yes”, analysis results will be imported from SCIA Engineer. This option will not be available if the “Type of members to create in Revit” option is set as “Structural”.

Ignore generated loads on load panels – If this option is set to “Yes”, only the applied loads on load panels will be considered when importing the model from SCIA Engineer. The generated loads on the load panels will not be imported. This option will not be available if the “Type of members to create in Revit” option is set as “Structural”.

Ignore reinforcement - If this option is set to “Yes”, the reinforcements are not considered when importing the model from SCIA Engineer. This option will not be available if the “Type of members to create in Revit” option is set as “Analytical”.

Create levels – The levels in Revit are created based on the selected option.

- Based on Stories – Levels will be created based on the Z coordinates of the stories in SCIA Engineer.
- Based on slab - Levels will be created based on the Z coordinates of the slabs in SCIA Engineer.
- Based on Z coordinates - Levels will be created based on the Z coordinates of 1D/2D members in SCIA Engineer.
- Use Revit levels – Levels will not be created while importing the SCIA Engineer model and elements will instead be attached to the existing levels defined in Revit document.

Update reinforcement geometry - If this option is set to “Yes”, the application will recreate the reinforcement. Setting this option “No” will update the reinforcement size and spacing, but not the geometry and other properties. This option will not be available if the “Type of members to create in Revit” option is set as “Analytical”.

Update 2D Member Openings – If this option is set to “No”, the 2D member openings will not be updated in the Revit model when importing the model from SCIA Engineer.

Update member size only - If this option is set to “Yes”, the application will update only the materials, types of frames and columns (dimensions of 1D members), thickness of floors and metal decks.

Update elevation of level based on storey – This option is applicable only if the model was imported from SCIA Engineer to Revit and having levels created based on Stories. In this case, when you update the Revit model after making some changes in SCIA Engineer, you have two options to update the

levels. Setting the option to “Yes” will update the Revit levels based on the Z coordinates of the stories. Setting this option to “No” will leave the levels in Revit unchanged.

If this option is set to “Yes”, the levels which were created based on Stories in the previous import will be updated. 2D member openings will not be updated in the Revit model when importing the model from SCIA Engineer.

User mapping

The following user mapping option makes the export option easier when a suitable material is not found the members.



If the ‘Material as unknown’ is set to “Yes”, the program will not prompt you for mapping a material whenever a material is not found in the mapping database. This option is redundant for Timber materials and for all materials in the “File Exchange” mode.

Mapping details

CADS Revit SCIA Engineer link is being shipped with pre-installed mapping databases which matches cross-sections and materials between **SCIA Engineer** and **Revit**. This database contains the mapping for different Revit families and its types with SCIA Engineer sections.

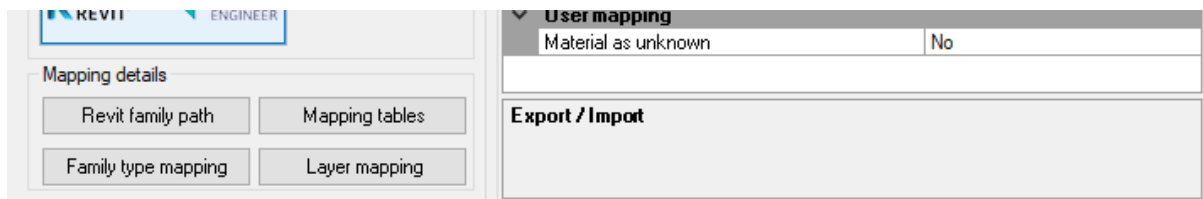

Revit family path

The default location for the families on your hard drive is **C:\ProgramData\Autodesk\RVT 20xx\Libraries\English\UK...** You may specify the library path in Revit as,

 Revit -> File-> Options-> File Locations -> Places ->

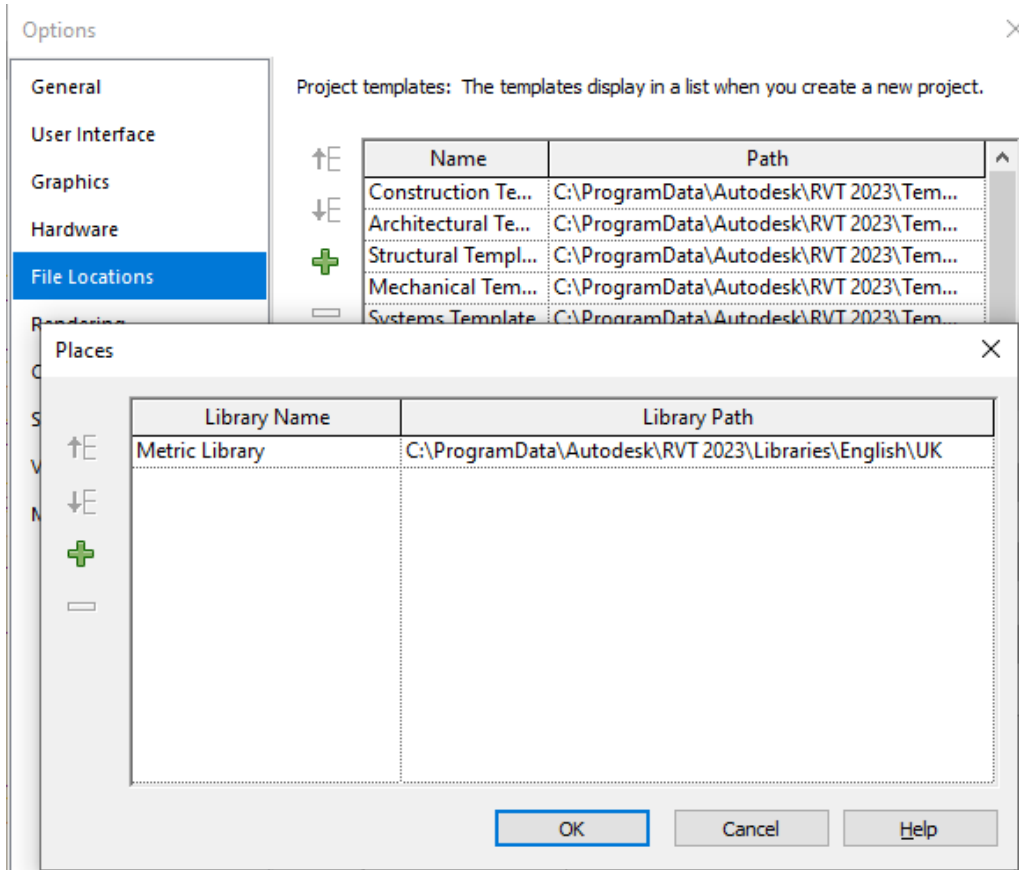

In case, you like to use custom families or would like to use different libraries, you can specify the Revit family path using the options “Revit family path”.

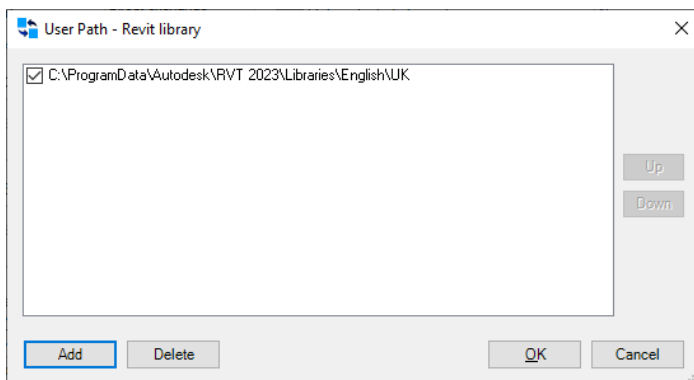

The application will browse through the specified locations in the order in which the path is specified and these families will be loaded into the document during import from SCIA Engineer.

Mapping tables

Refer section “Mapping tables” for details.

Revit Family type mapping

The Standard steel section family types in Revit are mapped with the section types in SCIA Engineer. You may review the family type mapping by clicking on this button “Revit Family type mapping”. Please note, this is a read only table.

Region	Family role	Family name	Family type	Section type
Europe Specific	Frame	IPE-Beams	IPEA	IPE
Europe Specific	Frame	IPE-Beams	IPEO	IPE
Europe Specific	Frame	IPE-Beams	IPEP	IPE
Europe Specific	Frame	IPE-Beams	IPEV	IPE
Europe Specific	Frame	IPN-Beams	IPN	IPN
Europe Specific	Frame	L-Angles	CAE	RSEA
Europe Specific	Frame	L-Angles	CAE	HFLeq
Europe Specific	Frame	L-Angles	CAE	ISEA
Europe Specific	Frame	L-Angles	CAE	L(ARC)
Europe Specific	Frame	L-Angles	CAE	L(CSN)

Layer mapping

The application will export the members into different layers to SCIA Engineer based on their category. The category includes “Frames, columns, Plates and Walls”. For each of these categories, you can specify the layer names or optionally load the default names from the standards. This mapping will be used only for exporting the model from Revit to SCIA Engineer.

Category	Value
Frame	S-280-M_BEAM
Column	S-280-M_COLUMN
Plate	S-230-M_FLOOR
Wall	S-200-M_WALL_ANLY

4.4 Node format

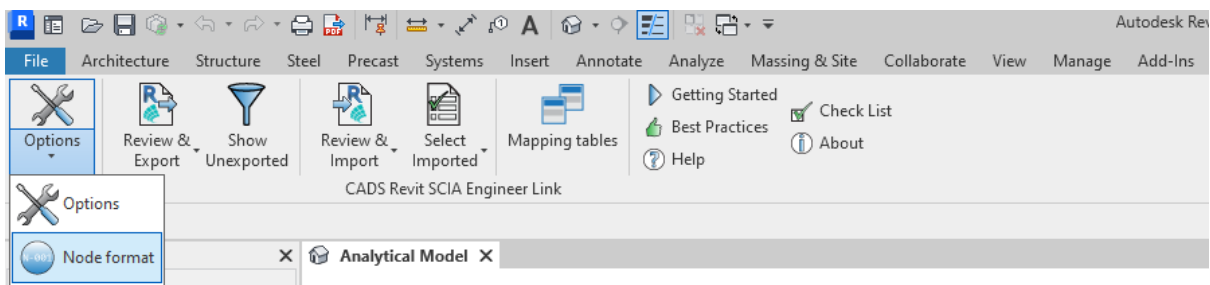

The “Node Format” can be used to configure the node name when exporting from Revit to SCIA Engineer for the first time for each project.

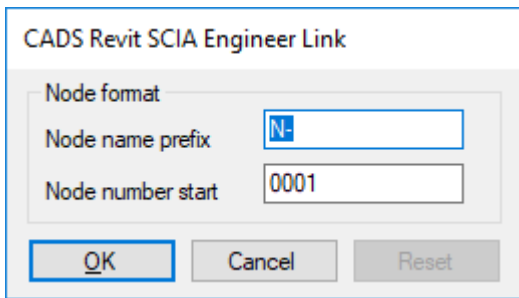

4.5 Export

The “Export” command exports the Revit model into SCIA Engineer using the current user options.

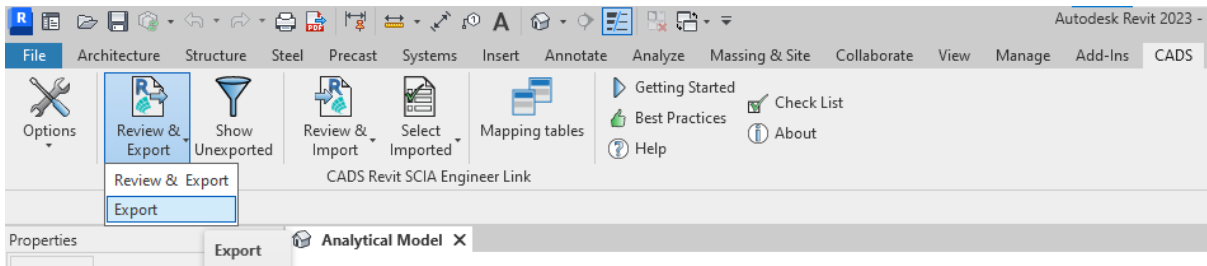

4.6 Review and export

The “Review and Export” command can be used to review the current model changes and export the selected changes.

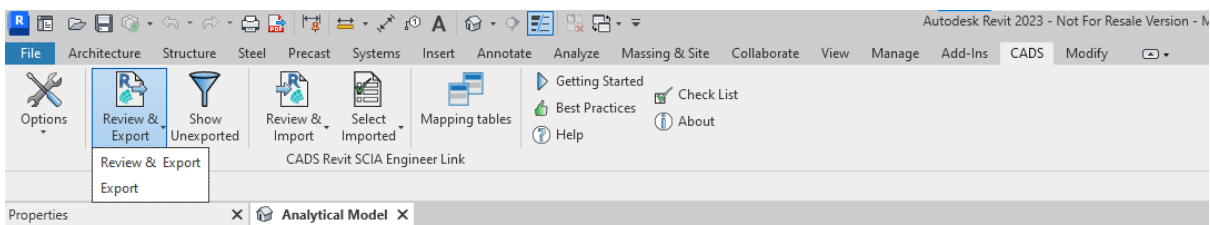

The application opens the review manager dialog that will list the changes to export by comparing the current Revit model with the last exported model. If this is a first time export, it will list all the items as ‘New’ under the ‘Changes’ column as shown below.

Id	Category	Section	Material	Changes	Export
184891	Structural Columns	(RC1) 200x500mm	Concrete - Cast-in-Place Concre...	New	<input checked="" type="checkbox"/>
202925	Structural Columns	(RC2) 250mm Dia	Concrete - Cast-in-Place Concre...	New	<input checked="" type="checkbox"/>
202927	Structural Columns	(RC2) 250mm Dia	Concrete - Cast-in-Place Concre...	New	<input checked="" type="checkbox"/>
202929	Structural Columns	(RC2) 250mm Dia	Concrete - Cast-in-Place Concre...	New	<input checked="" type="checkbox"/>
202931	Structural Columns	(RC2) 250mm Dia	Concrete - Cast-in-Place Concre...	New	<input checked="" type="checkbox"/>
202933	Structural Columns	(RC2) 250mm Dia	Concrete - Cast-in-Place Concre...	New	<input checked="" type="checkbox"/>
202935	Structural Columns	(RC2) 250mm Dia	Concrete - Cast-in-Place Concre...	New	<input checked="" type="checkbox"/>
202937	Structural Columns	(RC2) 250mm Dia	Concrete - Cast-in-Place Concre...	New	<input checked="" type="checkbox"/>
202939	Structural Columns	(RC2) 250mm Dia	Concrete - Cast-in-Place Concre...	New	<input checked="" type="checkbox"/>
217476	Structural Framing	(GB1) 450x450dp RC Ground Beam	Concrete - Cast-in-Place Concre...	New	<input checked="" type="checkbox"/>
217512	Structural Framing	(GB1) 450x450dp RC Ground Beam	Concrete - Cast-in-Place Concre...	New	<input checked="" type="checkbox"/>

The review manager lists the element ID, member category, cross section, material, type of change and an option to export. The preview on the left zooms to show the selected ID.

The following changes to structural members and openings are tracked by the review manager in this release:

- New - when a new item is available in the current model;
- Cross section – changes to the cross section (for example UB 305x102x25 to UB 305x127x37 or wall thickness changed from 200 mm to 300 mm);
- Dimension – changes to length of 1D members such as beam, column and changes to dimensions of 2D elements such as slab;
- Position - if the structural element is moved from its previous position, including changes in eccentricity;
- Rotation – changes to cross section rotation;
- Material – changes to material;
- Member releases – changes to member end releases such as hinges in SCIA Engineer;
- Opening – changes to opening dimension, position;
- Delete – when a member is deleted in SCIA Engineer.

Changes to *Loads* and *Supports* are not tracked by the review manager yet.

Elements deleted from the Revit model will not be listed as the review manager compares just the currently available items.

You can save the contents of the review manager into a file by clicking on the *Save log* for future reference. Clicking on the *Export To* option in the preview allows you to save the file to multiple file formats.

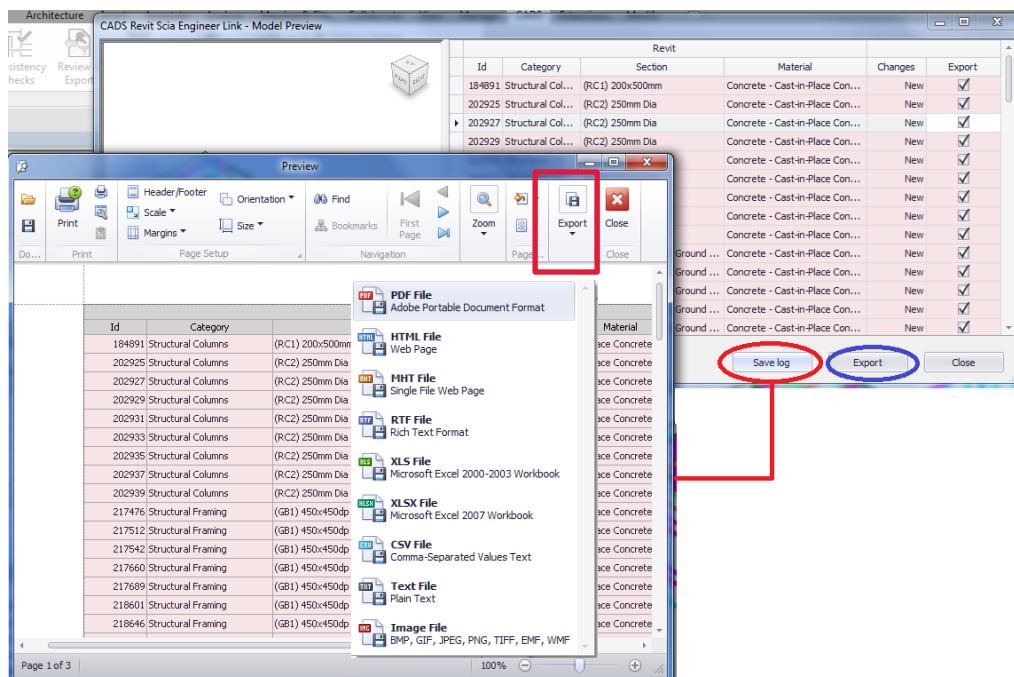

Using the selection in the last column (*Export*) you can choose not to export a particular element by un-ticking it.

4.7 Show Unexported

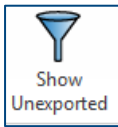

“Show Unexported” is meant for displaying and selecting the Revit members that are not exported after the export process is finished. This command will display the following dialog.

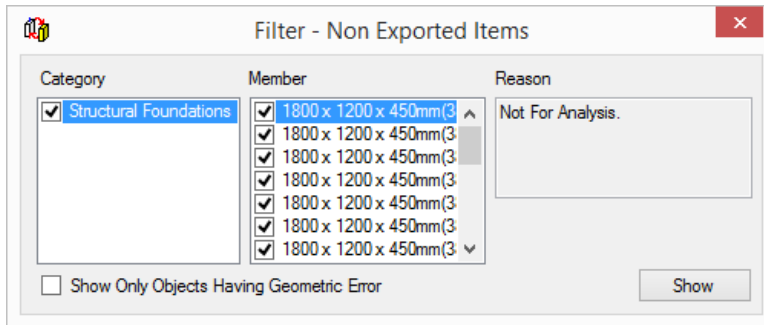

Selecting the required items in the list and selecting *Show* selects the members in the selection set and zooms the selected items to the full extent.

4.8 Review and Import

The “Review and Import” command can be used to review the current model changes and import the selected changes.

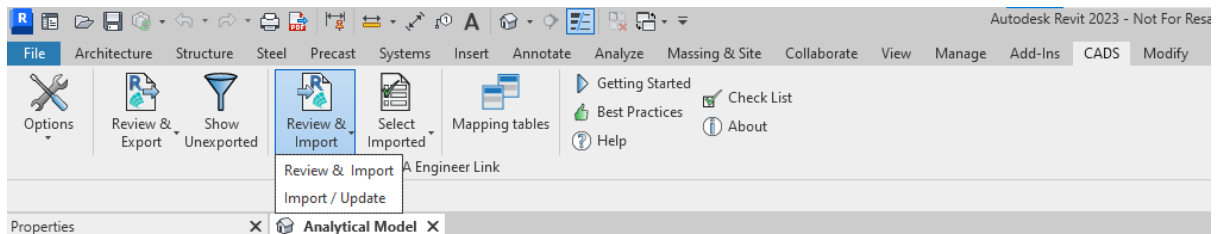

The application opens the review manager dialog which could be used to track the changes between the SCIA Engineer model and the current Revit model.

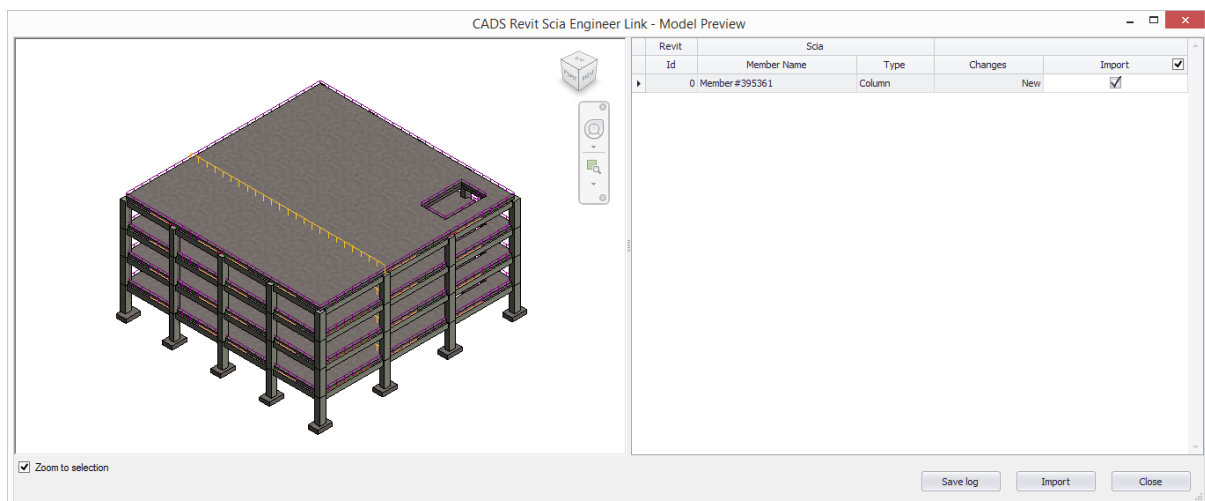

You can choose not to import a change by using the option in the last column. This is particularly helpful if the changes are specific to analysis.

During import, *CADS Revit SCIA Engineer Link* will always update the existing model available in Revit. If you are interested to update only the member size of 1D Members, material, Thickness of 2D members and Profile sheet, you may choose the option “Update Member size only to “Yes” in the Options dialog.

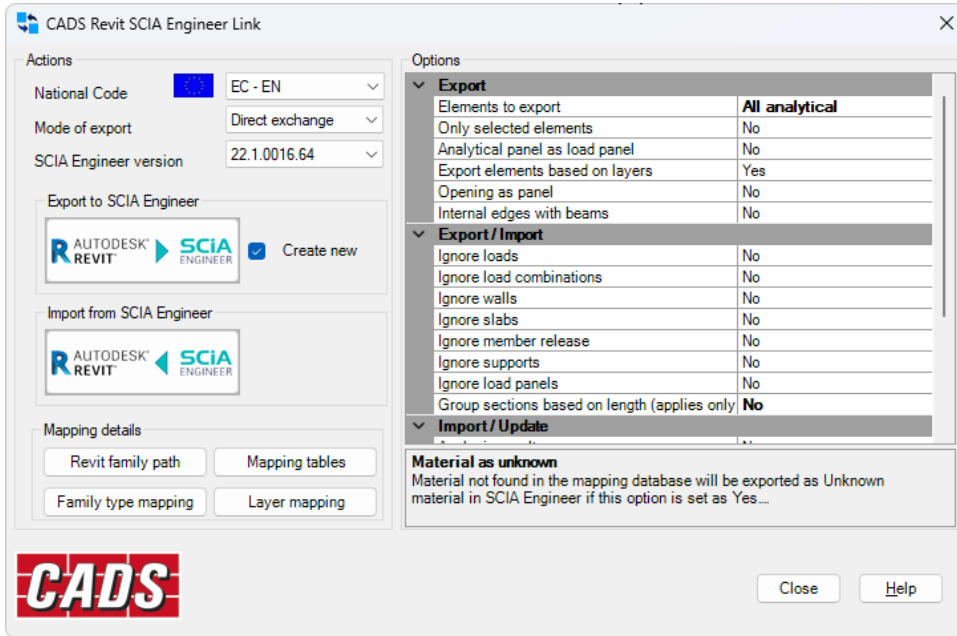

4.9 Import

Selecting “Import/ Update” command imports/ updates the Revit model from SCIA Engineer using the current user options.

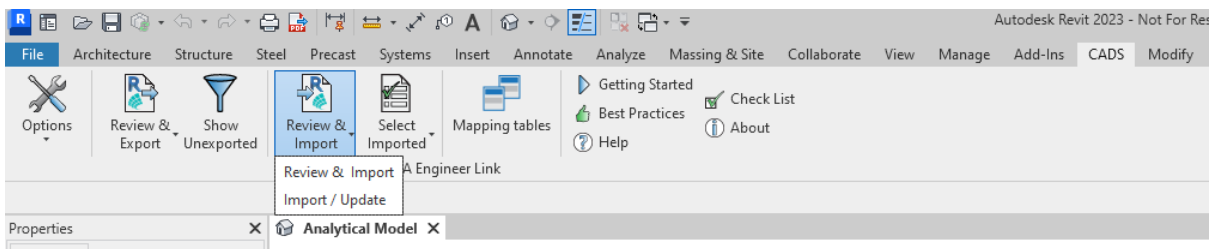

4.10 Select Imported

“Select Imported” command can be used to control the entities or the elements that are to be imported from SCIA Engineer.

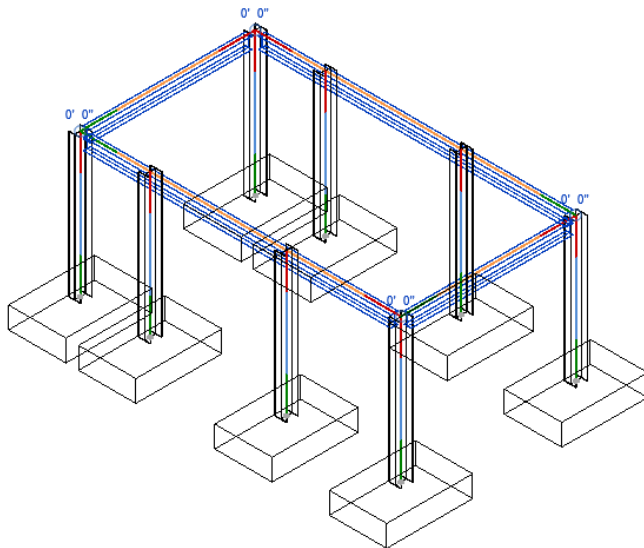
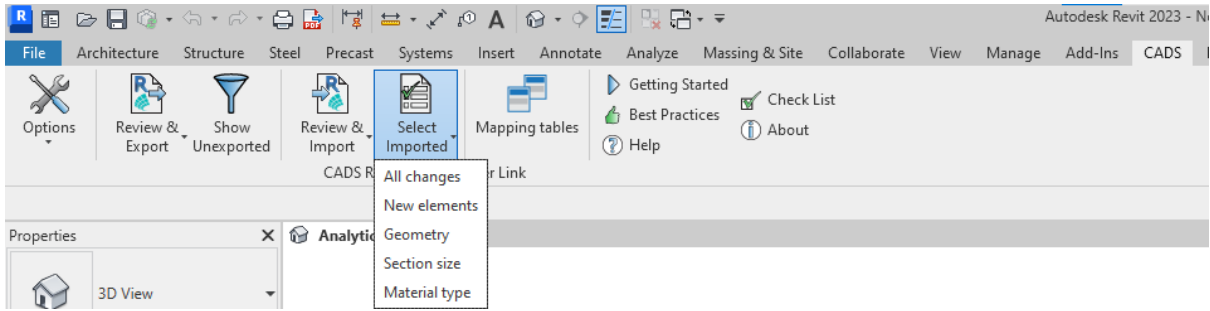

4.11 Mapping tables

The “Mapping Tables” option allows you to create/load /add the mapping data between Revit and SCIA Engineer.

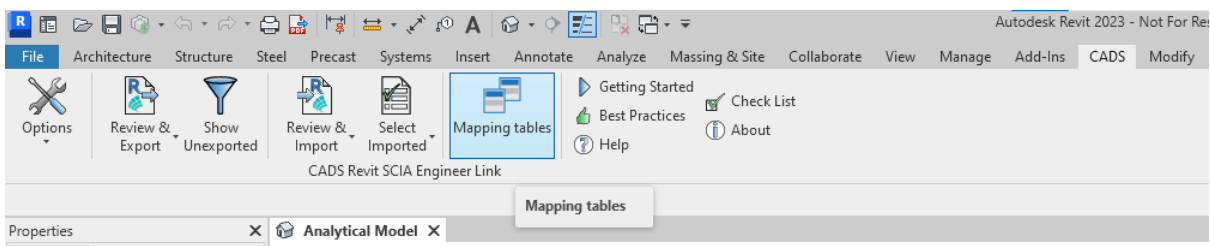

The application opens the *Mapping tables* dialog from which you can create/load the mapping of materials, cross-sections and profile sheet. Please refer to the section “Mapping tables” for more details.

4.12 Getting started

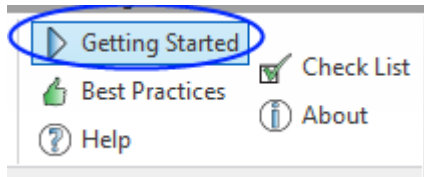

Selecting “Getting Started” will open the *Getting started guide*.

4.13 Best practices

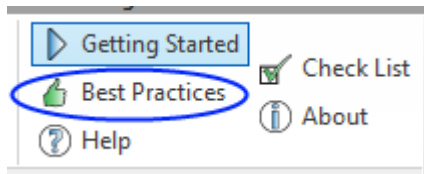

Selecting “Best Practices” this will open the *Best Practices guide*.

4.14 Help

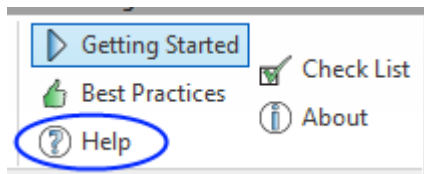

Selecting “Help” will open the help document.

4.15 Check list

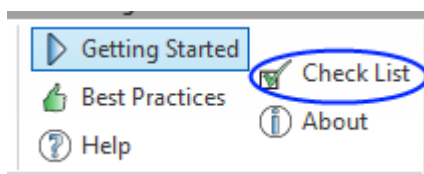

Selecting the “Check List” command will open the check list document for reporting an issue or a bug.

4.16 About

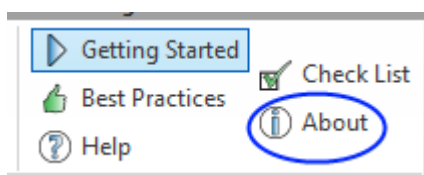

Selecting “About” will display the “About box” through which you can verify the version number and access the release notes.

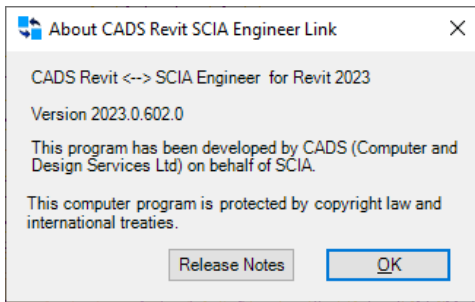

5 Mapping Tables

The standard cross section and material libraries in both Revit and SCIA Engineer are comprehensive but are labelled differently. *CADS Revit SCIA Engineer link* is shipped with a pre-installed mapping database which matches cross-sections and materials between SCIA Engineer and Revit. The database contains the mapping for different Revit families and its types with SCIA Engineer sections.

In many cases, in Revit, you may require to use custom families in addition to the standard families. In such cases, the pre-defined database which contains the entries of standard mapping is not enough to transfer the data between Revit and SCIA Engineer.

CADS Revit SCIA Engineer link provides a tool “Mapping tables”, to map the custom Revit families with equivalent SCIA Engineer materials/ sections. The user defined mapping entries can be stored as a “database” and can be used across projects/users.

“Mapping tables” command can be accessed from ribbon and from the Options dialog. When it is accessed from ribbon, you will be able to import/export/save and delete the user defined databases. When it is accessed from Options dialog, you will be able review the standard and user mapping databases. The following sections will discuss in detail the features of mapping tables.

5.1 Mapping Tables from Ribbon

Click on “Mapping tables” command from Ribbon.

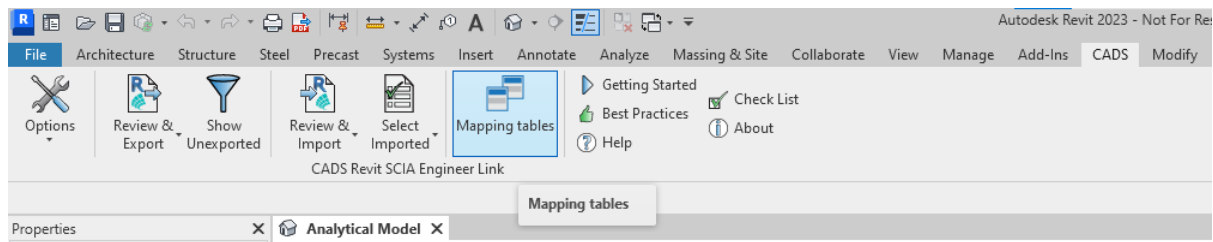

The Mapping tables dialog will be shown:

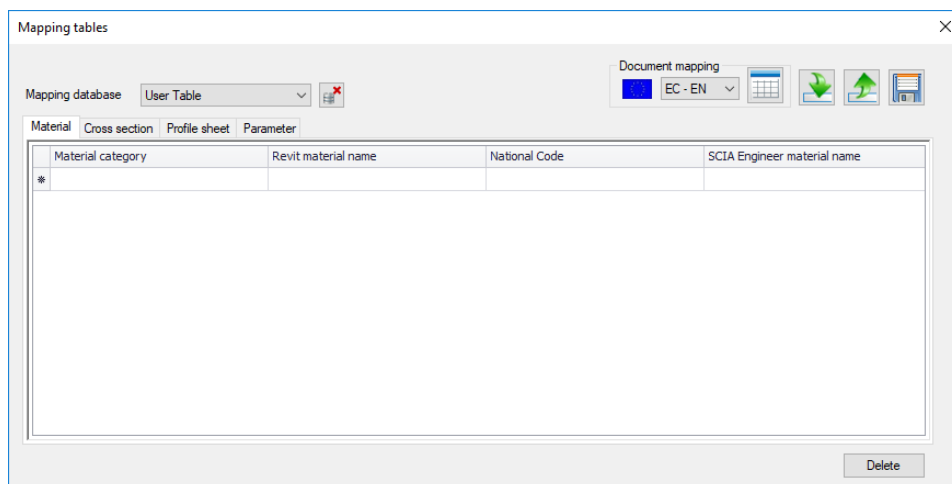

The features of the mapping tables are detailed below.

5.1.1 Mapping database

The application will list all the user defined databases. By default, there will be a blank user table (database). You may import the existing database using the option “Import database”. Once the valid database is imported, it will be added into the list.

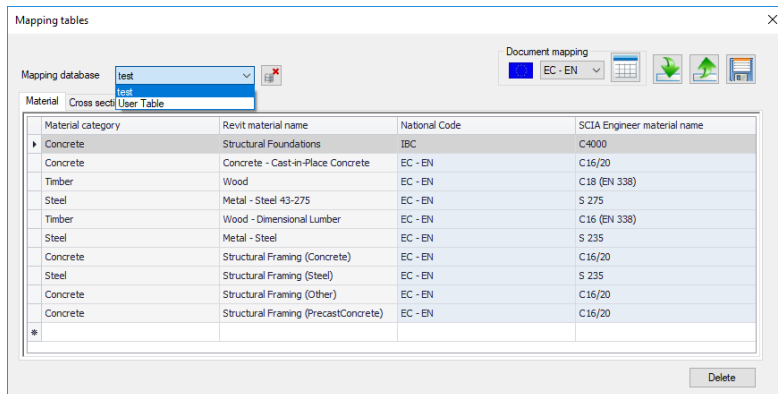

Mapping entities, for both export and import, works on the basis of the database(s) you have selected, so you need to select the appropriate database from the list for the transfer to work correctly.

Please refer to the section “User table” for details of adding/deleting entries into the user table.

5.1.2 Document mapping

You can use the “Document mapping” option to map all the materials, sections (standard and parametric) and profile sheets that are used in a Revit document in one go. This will avoid the extra work involved in having to create individual entries for all materials/ sections of Revit families used in the document.

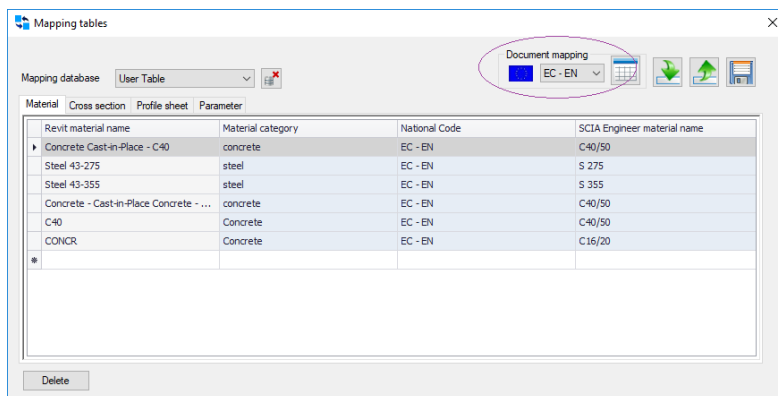

On clicking the “Document mapping” button, the application will read through all the materials/families used in the document and will try to automatically find the equivalent SCIA Engineer materials/sections.

Please note, the selection of National code is important as the material mapping depends on the selected National code. It is recommended to change the National code prior to using the Document mapping feature.

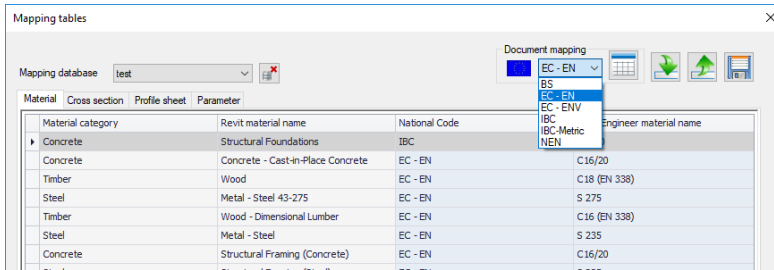

Material mapping

Mapping Revit materials with SCIA Engineer materials is primarily based on the material class, National Code and the strength of the Revit material. If all the parameters are matched, the application will automatically map it to the equivalent SCIA Engineer material. If one or more parameters do not match, the application will display the material mapping dialog and you will need to map the equivalent materials.

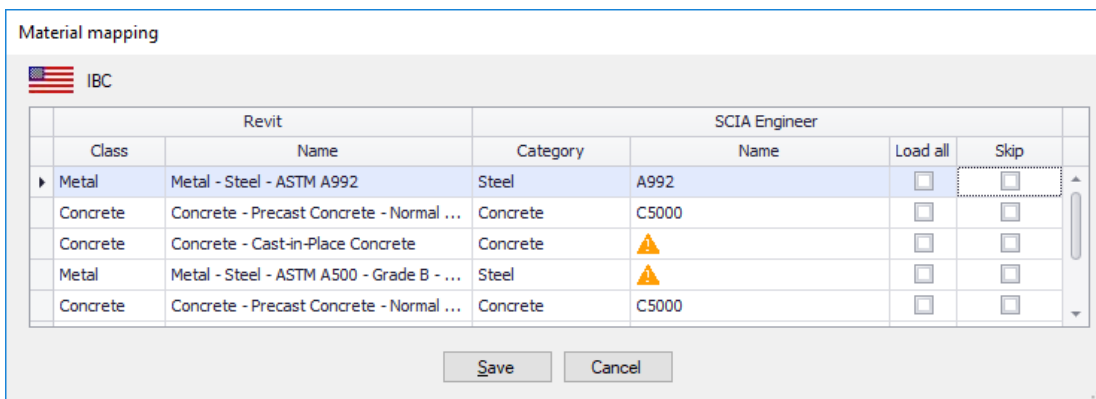

To make the user mapping easier, the program will offer guidance by suggesting equivalent materials. The list of suggested materials is made up of those materials which satisfies one or more criterion, from which you could pick the desired material.

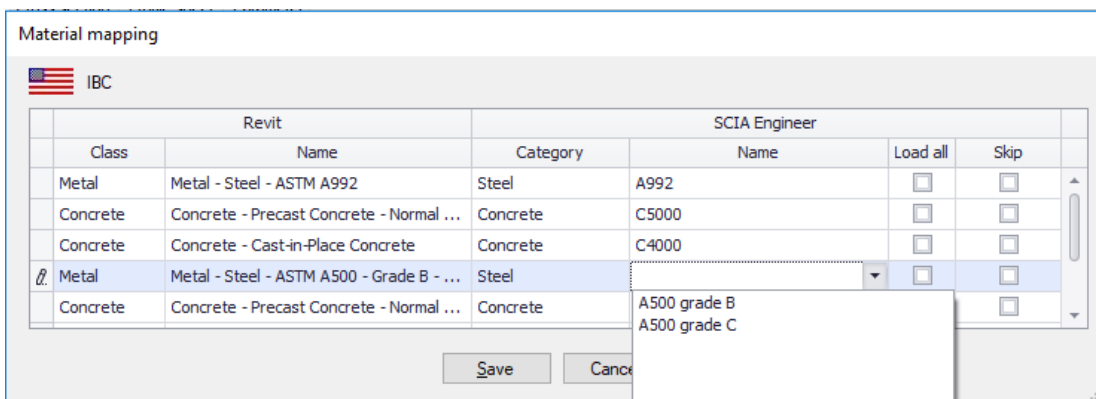

If you are not satisfied with the suggested list, you can use the “Load all” option to load all the materials in SCIA Engineer (filtered based on National code and category) and select the material of your choice.

If the material class in Revit is Concrete, Metal, Masonry, or Wood, the application will, by default, set the appropriate category and you can then select the correct material from the standard list of materials that are available in SCIA Engineer for the selected national code.

If the material class in Revit is “Unassigned or Miscellaneous”, the application will allow you to choose any Material category and then any material in that category. Alternatively, you may skip the mapping

by checking the “Skip” checkbox. However, in this case you will need to map it during the export or chose to export the material as “Unknown”.

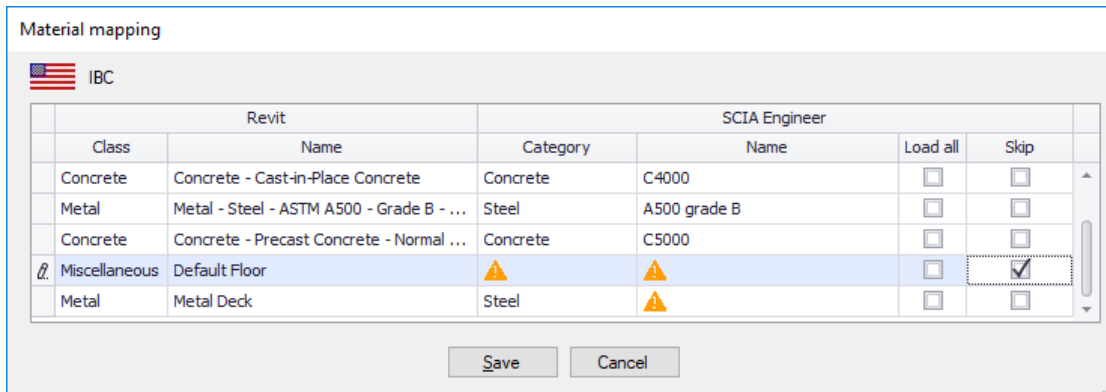

The materials that you have mapped will be added into the user table, and will be available for subsequent export in other projects.

Profile sheet mapping

After the materials are mapped, if metal decks are used in the Revit document, the application will then navigate to the “Profile sheet mapping” dialog. Profile sheet mapping is carried out based on pre-defined rules for the standard steel metal decks with Revit families. Standard profile sheets will be loaded based on the National Code and the manufacturer’s product catalogues that are supported by the link.

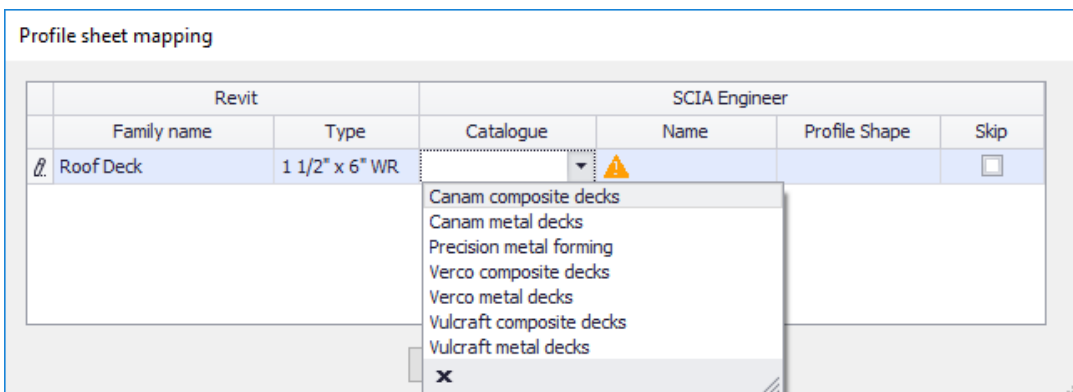

The catalogue name is identified from the family name and deck type is identified from the family type. If the name of family type matches exactly with the SCIA Engineer deck type, the application will automatically map the profile sheets. When the link encounters a family/ family type that is not in the SCIA Engineer list, you need to map the appropriate catalogue name and the deck type.

Cross section mapping (Standard Steel Profiles)

After the materials and profile sheets are mapped, the application will then navigate to the “Cross section mapping” dialog. Section mapping is carried out based on pre-defined rules for the standard steel profile sections with Revit families.

A simple database is prepared for the standard profile shapes of SCIA Engineer with Revit families. This database replaces the multiple databases (2018 and earlier versions of the link) and contains mapping for Revit families with SCIA Engineer section types. Based on the family name, the application will find the equivalent SCIA Engineer section type by reading it from the mapping database. After finding the section type, the appropriate SCIA Engineer section is identified based on the family type.

If the name of Family type matches exactly with SCIA Engineer section, the application will automatically map the sections. But, when the link encounters a family/ family type that is not in the SCIA Engineer section tables, the application will try to find the near equivalent section(s) and list them. The suggested sections will be shown in the Section list.

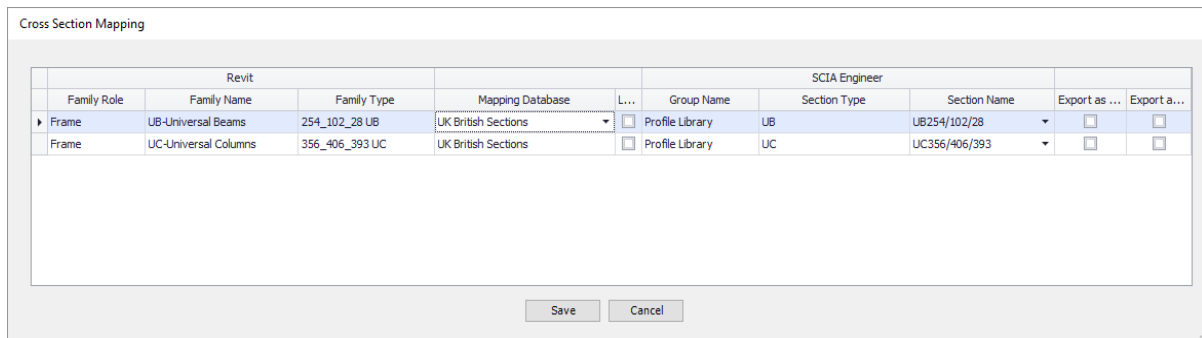

Based on the parameters of the mapping criteria, it is possible that the application finds more than one suitable section. In such cases, the application will list all the possible sections in the Section list from which you can pick the desired section.

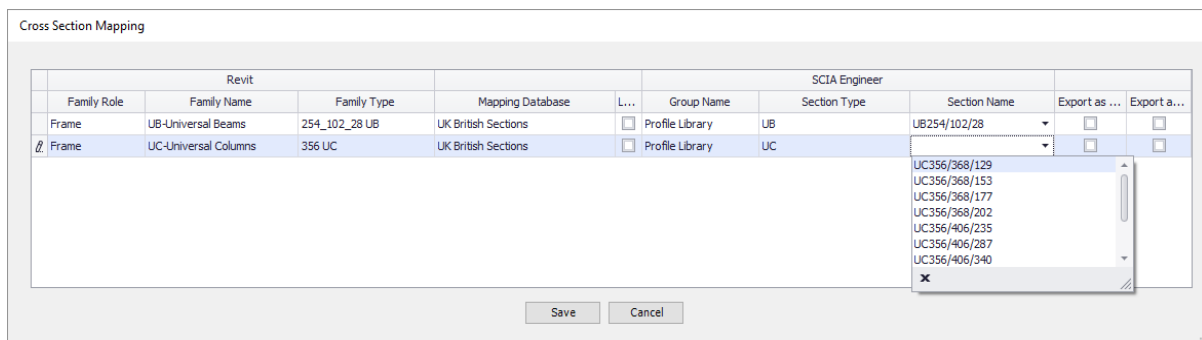

In case you are not happy with the suggested section list, you can ignore the suggested list. To do so, check the “Load all” option and can click on the “Section Name” button to pick any other equivalent section from the “Profile library”.

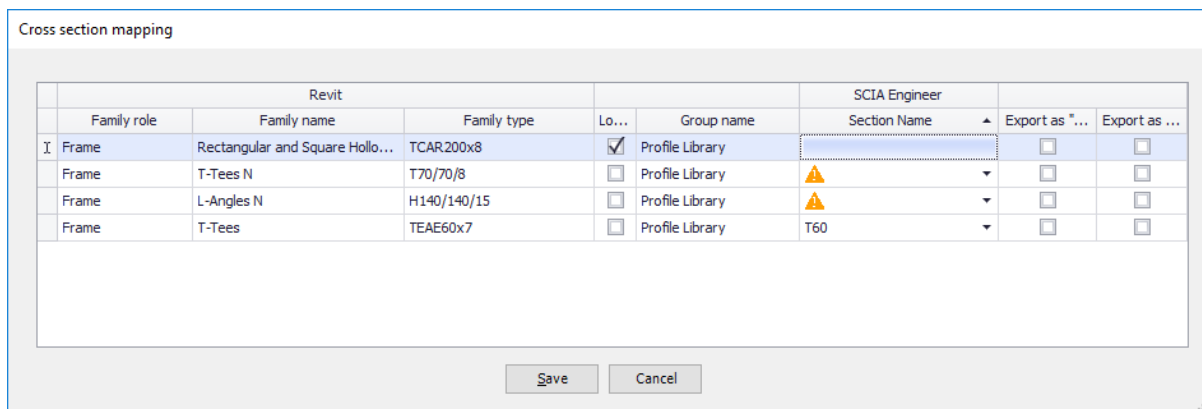

The “Profile library” is a new dialog that has been introduced to show the equivalent standard profiles of SCIA Engineer. This dialog lists all the standard sections of SCIA Engineer from which any standard profiles can be selected. The Profile library has filters based on the regions (Country) to make the selection easier.

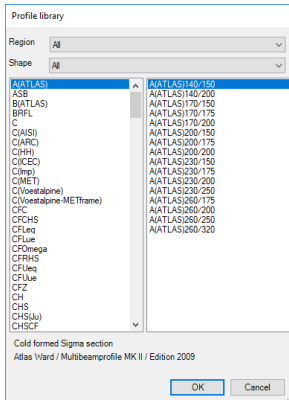

Cross section mapping (Parametric mapping)

Concrete, timber, precast, plate girders, thin-walled and geometric sections, which are defined using dimensional parameters, will require their Revit dimensional parameters to be mapped to the corresponding SCIA Engineer parameters.

When such sections are used in the Revit model, the application will group them based on the material of the member. The “Group name” is listed based on the group in SCIA Engineer. Please refer to the following table which lists material of the member and its group options.

Material of the element	Default Group	Group options
Concrete / Precast	Concrete	Concrete, Geomteric and Precast
Wood	Timber	Timber, Geomteric
Steel	Profile library	Profile library, Geomteric, Pairs, Closed, Haunch, Sheet Welded, Build-In beams and Thin-walled Geomteric.

For members with “Steel” materials, the default group would be “Profile library”. If you would like to use a different group, check the “Load All” button.

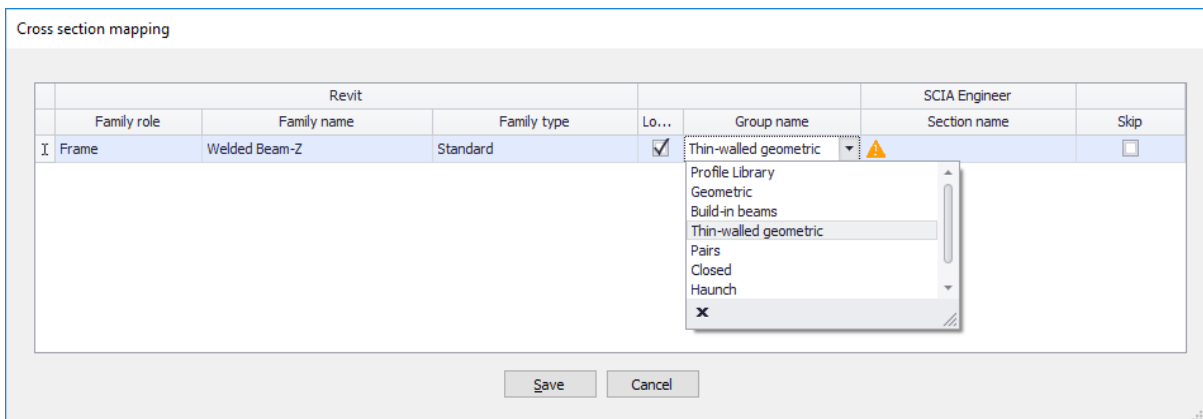

Select the group that you would like to use and then click on the “Section Name” button to open the parameter mapping dialog.

The following table lists the section types for each selected group.

Group	Section types
Concrete	Rectangle, I ng, T g ,L g ,L- g ,Circle, Oval
Geometric	I ng, I gh, Rectangle, Circle, Oval, T g, L g, U g, Tube, X, Z, O, C, O Asymmetric, Polygon

Timber	RECT, CIRC, 2 Rect, 3 Rect, T profile, I non-symm, I symm, Box, Box 1, Box 2, 2 Rect, 3 Rect, Cross, 2+1 El.fill, 2+3 El.fill, 3+2 El.fill
Pairs	2I, 2Uc, 2Uo, 2LT, 2LX, 2LU, 4LX, 4LU, 2LTn, 2LUn, 2LX , 2xTube, 4xLc, lvar, 2CFUo, 2CFUc, 2CFCo, 2CFCc, 2CFLT
Closed	Box fl, Box web, 2U box, 2I box, 2U+2PI box, 2L box, 4L box, U+PI box, PI+L box, Polygon with hole, I + 2PI
Haunch	I + I var, I + PI var, lw + PI var, lw + lw var, lw + l var, l var, I + lw var, I + 2 l var, I cellular symmetric, I cellular asymmetric
Sheet welded	lw, lwn, Uw, Tw, Lw, llw, TTW, lw+2L, Lw+LI, lw+Lr, IXw, IXwn, IW+Twl, lw+Twr, lw + rail, lwn + rail, SIN1, SIN2
Build-in beams	SFB, IFBA, IFBB, THQ
Thin-walled geometric	I, RHS, CHS, Angle, Channel, T, Full Rectangle, Full Circle, Asymmetric I, Rolled Z, Cold Formed Channel Section, Cold Formed C Section, Cold Formed Z Section
Precast	Precast1, Precast2, Precast3, Precast4, Precast5, VSTI - Precast6, Precast7
Welded, Bridge, Composed Symm bridge, Composed, Fabricated and Westok	Not supported.

Based on the selected section type you chose, the SCIA Engineer parameters will be displayed in a grid. You can now map the equivalent Revit parameters for each SCIA Engineer parameter. When you pick a Revit parameter, the actual values of the of that Revit parameter is read from the family and listed.

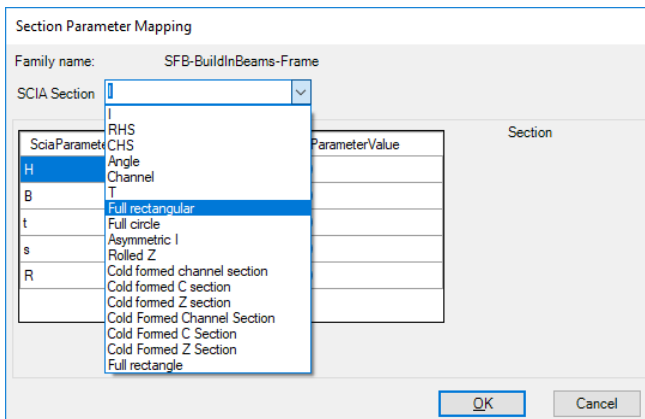

If there equivalent parameters are not available in the Revit family you may set the Revit parameter name as “None” and specify the value directly.

You will need to map the parameters for each family once.

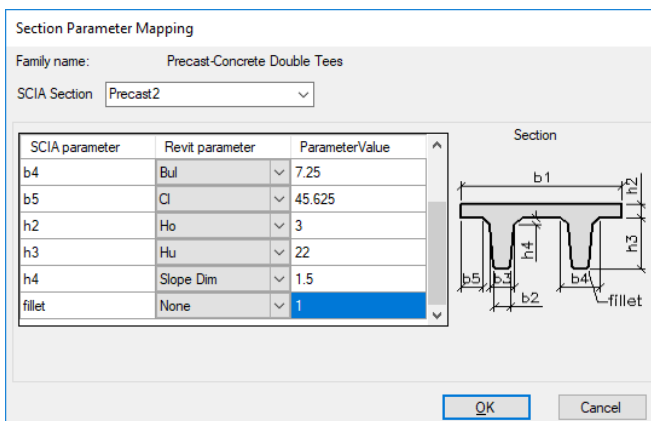

Paired sections, SlimFlor beams and Closed sections are mapped by selecting the basic steel section profiles from the standard steel section library and then entering the values of the additional parameters.

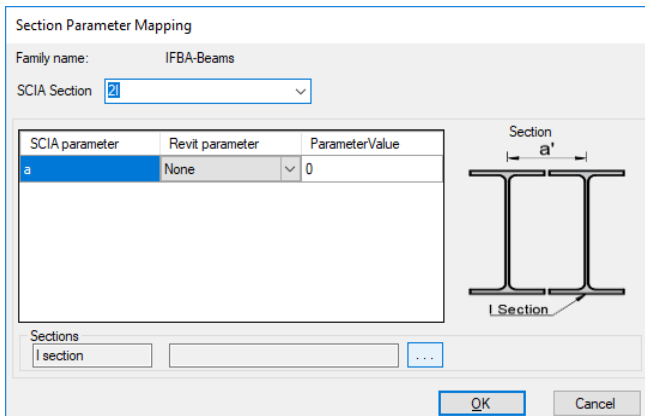

After mapping all the parameters, Click on the “OK” button. The application will create family types based on the parameters that you have mapped. You may review all the family types and the respective SCIA Engineer sections in the Parameter mapping tab.

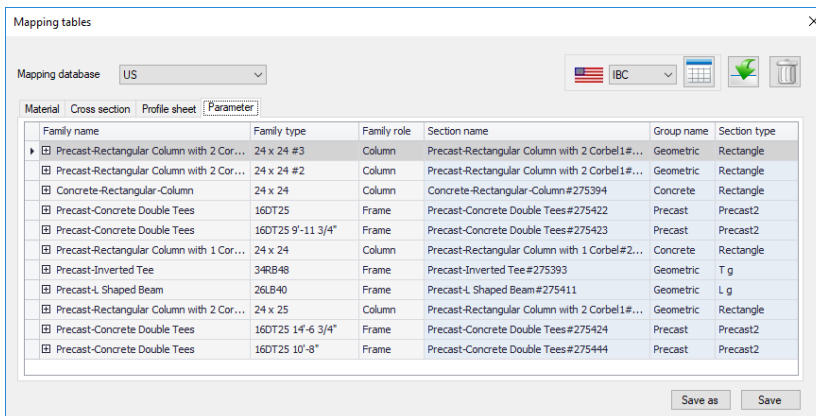

After all the materials, sections, profile sheets in the document are mapped, the application will give a message.

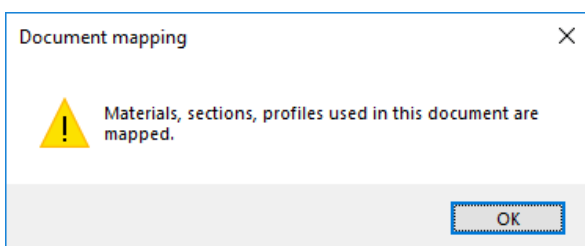

The mapping entries are updated to the current user table. The mapping details will be used for all subsequent exports/import in the current Revit project (document). You can also Save the user table and use it for other projects by using the Import option.

5.1.3 Save and Delete database

All mapped materials, profile sheets, cross sections (standard and parametric) can be saved and reused across all your projects and even by other users. Clicking on “Save” command will save the entries into the current “User table” (User database). The files will be saved in .xml format.

By default, the database is saved in... .\Users\xxxxxxx\AppData\Local\CADS\Revit to SCIA Engineer\Revit 20xx\Mapping Databases\.....xml.

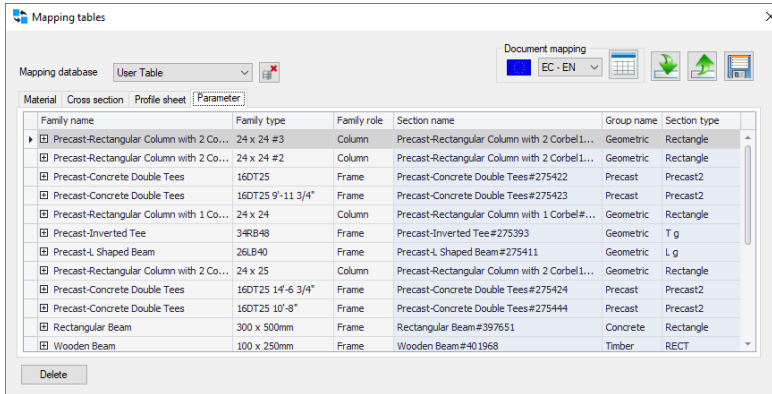

You may delete the database, by clicking on the “Delete database” button. If you have only one user table (database), the delete database button will not be shown. There should be at least one user table to be present.

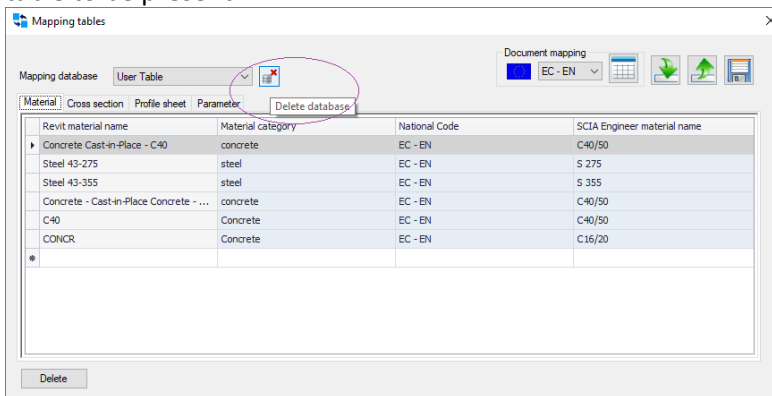

5.1.4 Import/Export database

You can import any user mapping database by clicking on the “Import database” button.

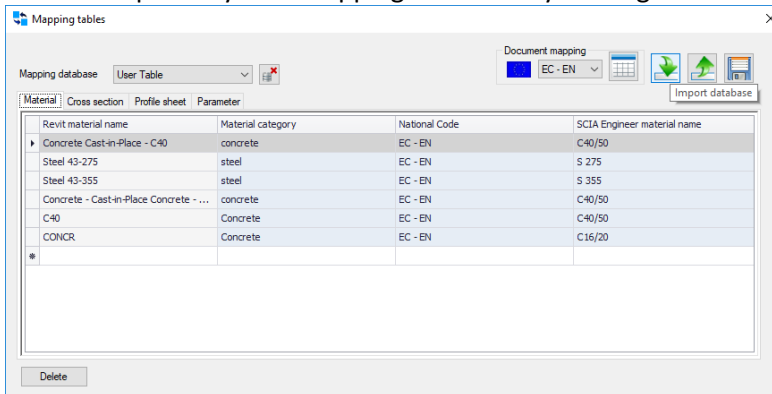

To import a user table (database) that has been saved elsewhere, click on the “Import database” button and select the file(s). The files will be copied into “..\Users\xxxxxxx\AppData\Local\CADS\Revit to SCIA Engineer\Revit 20xx\Mapping Databases\”. Any changes to the entries will be effected into this copied file and the original file will not be altered.

The imported databases will be used across the Revit projects. If you need to use it across different users/ systems, you need to share the file. This could be achieved by using the “Export database” command.

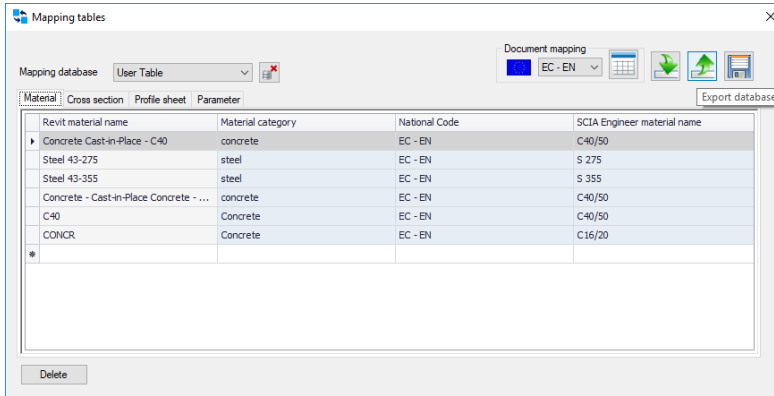

By clicking on this, you are prompted to specify the file name in the standard browser dialog.

5.2 Mapping tables from Options dialog

The “Mapping tables” can also accessed from the “Options” dialog.

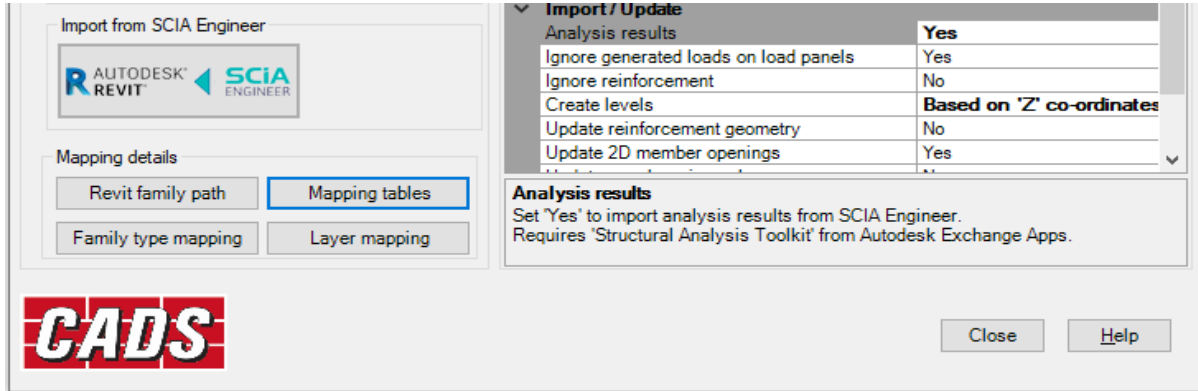

The Mapping tables dialog when it is accesses from here will list the standard pre-installed databases that are shipped with the *CADS Revit SCIA Engineer Link* along with the *User Table* used in the document.

You can use this feature to review the mapping of default Revit families (Materials, Profile sheet and Virtual joists) to the corresponding default SCIA Engineer materials/sections and the user mapping.

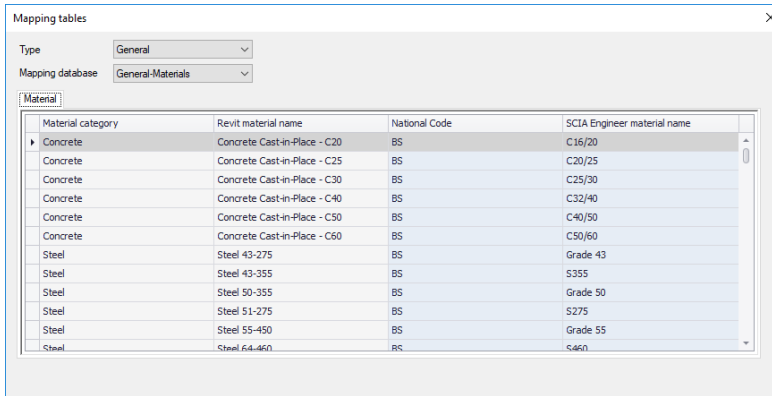

Select the database type as “General” and select the “General-Materials” database, will list the mapping of Revit materials and the corresponding SCIA Engineer materials. Selecting the “General-Profile Sheet” database, will list the mapping of Revit metal decks and the corresponding SCIA Engineer decks.

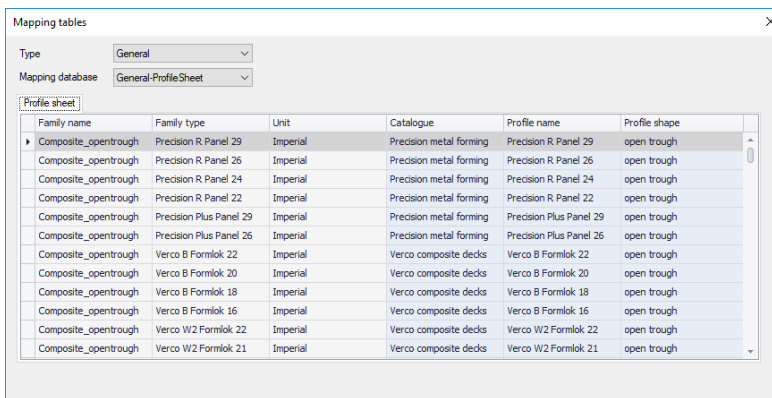

In the same manner, you can review the mapping of Virtual Joists, and Joist girders.

In addition to above, when you select the type as “User”, the database will be set to “User table” used in the current Revit document (project).

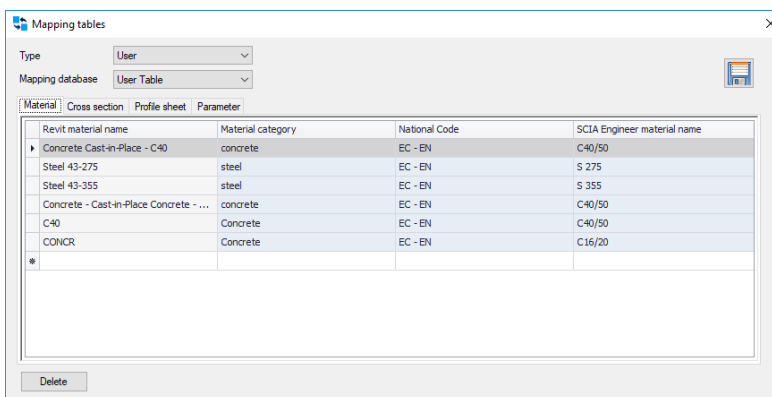

Please refer to the section “User Mapping” for more details regarding the user table.

5.3 User Table

If you use custom families for cross-sections, profile sheets, materials, it is required to map the equivalent SCIA Engineer entities and this can be achieved through user mapping. The mapping details (entries) are stored in “User tables”. The user tables are used along with the pre-installed databases during export and import process.

5.3.1 Adding mapping entries into User Table

Clicking on the *cell adjacent to the ** button allows you to add your customised mapping for the material/ cross-section/ profile sheet under respective tab.

For material mapping, you will need to specify the material category (by selecting it from the combo), choose the relevant material name and specify the equivalent SCIA Engineer material.

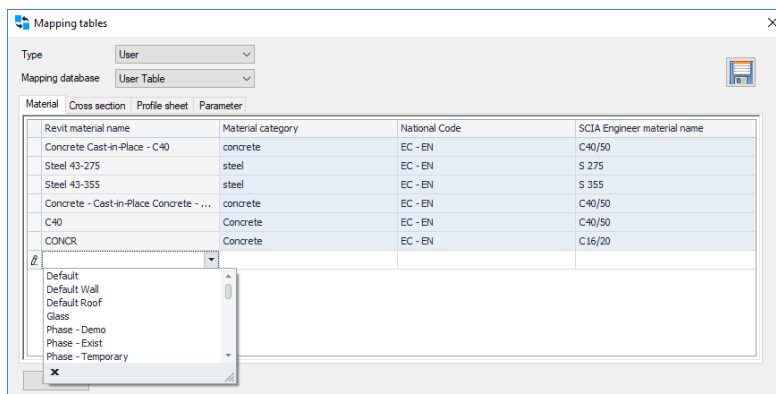

Revit materials in the document will be listed based the material class and SCIA Engineer materials will be listed based on the National code.

For Family (Cross-section) mapping, you need to select the Revit families and the equivalent SCIA Engineer section types.

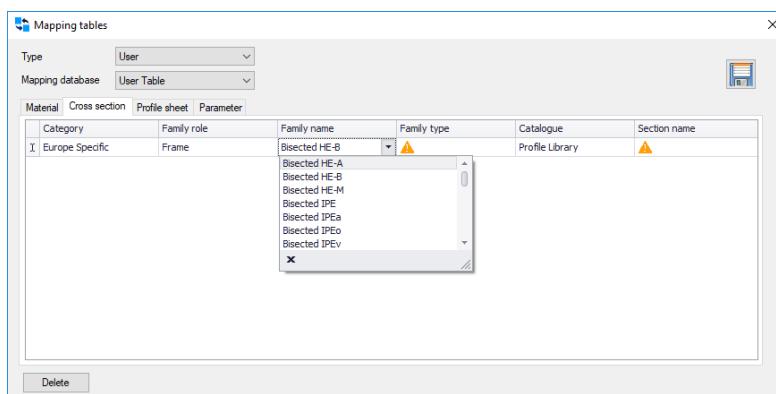

If you wish to map the customised Revit families or would like add/change the library, it is recommended to add the path where the families are stored in any of the following places using the “Add” option.

Revit -> File -> Options -> File locations -> Places Or Revit -> CADs -> CADs Revit SCIA Engineer Link -> Options -> Revit Family path

The last subfolder(s) of the selected path will be listed under “Category” and the Revit families will be listed under “Family name” based on the selected family role. You need to add your custom families into separate folders “Structural Framing” and “Structural Columns” according to their family role.

The Cross-section mapping is dedicated to standard profiles and hence using this option you will be able to map only the equivalent standard sections (and not those defined with their dimensional parameters) in SCIA Engineer in the “Profile library” dialog. This dialog will be shown on clicking the section name button in the dialog.

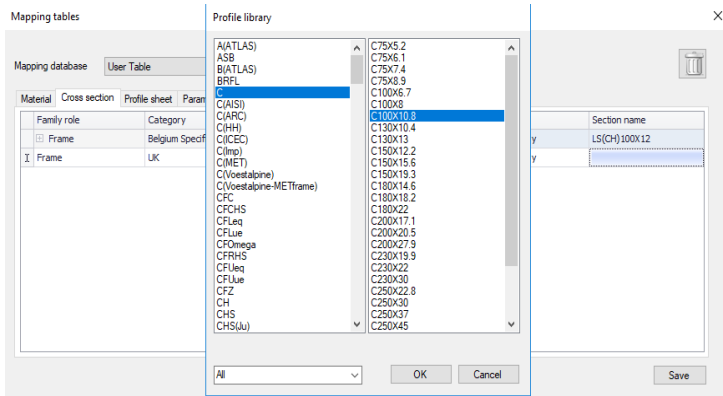

For families which are defined with dimensional parameters, use “document mapping” option. You will not be able to add mapping entries for parametric sections in the user table directly.

Mapping standard metal decks is similar to the material mapping and you can add entries to the user table as described in the previous paragraphs.

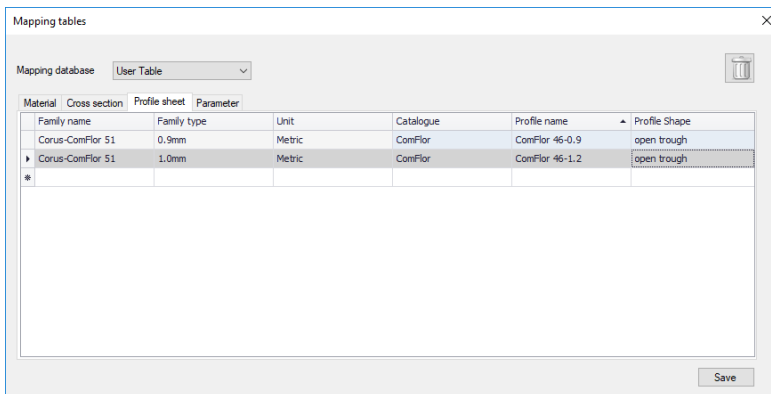

5.3.2 Delete entries from User Table

The entries added in the user table can be removed by deleting them using the “Delete” button or alternatively using the “Delete” key on your keyboard. The standard selection methods can be used to select and delete multiple entries in the list.

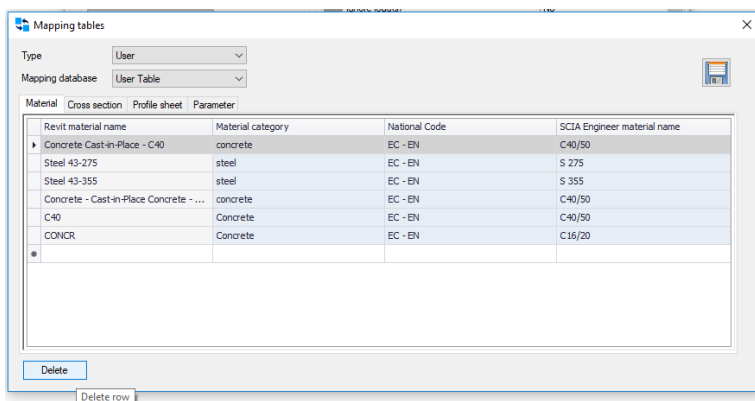

5.4 Mapping during Export/Import

During the Export/Import process, CADs Revit SCIA Engineer Link application will find the equivalent materials/ profile sheet / cross- section, by verifying the pre-installed databases and then by reading through the selected user table. You will be prompted to do a manual mapping only if the link application encounters a material / section / profile sheet that cannot be resolved from the pre-installed database.

5.4.1 User mapping during Export (Revit – SCIA Engineer):

The user mapping during export is very similar to the one detailed in the section “Document mapping” with the following exceptions:

- You will not be able to use the “Skip” option in the material mapping. You could, however, export the materials as “Unknown”.

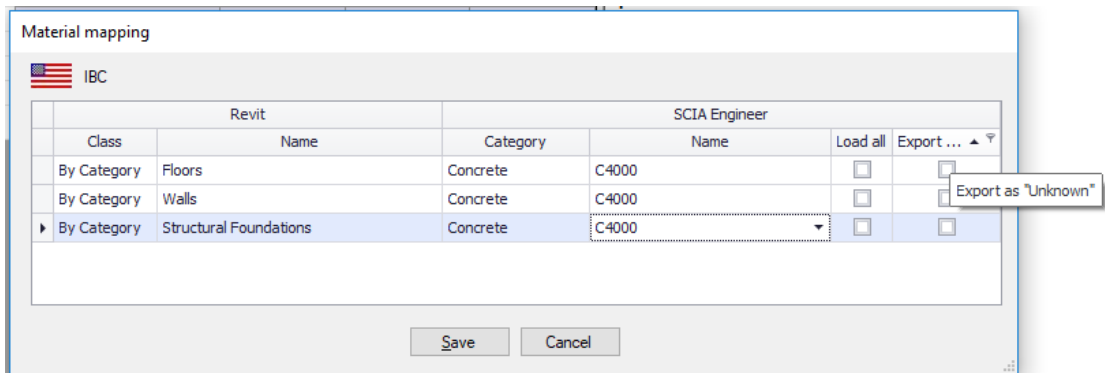

- While performing a cross-section mapping, you have the option to export the section as “General section”.

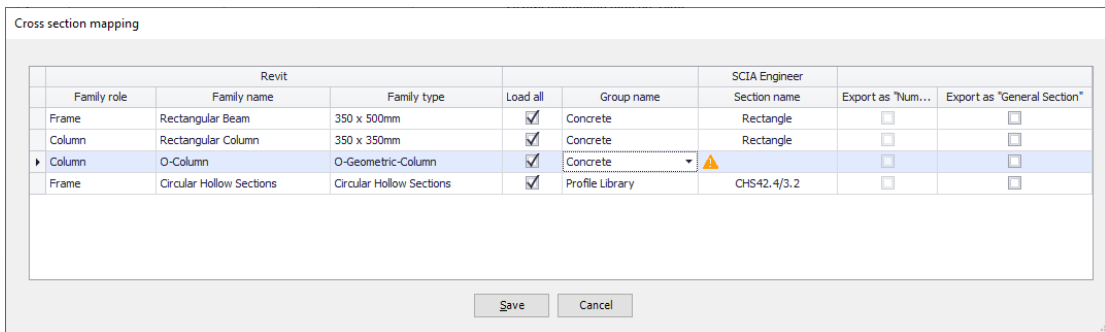

Note: The options “Export as Unknown”, Export the cross-section as “General” are available only for the Direct exchange method.

5.4.2 User mapping during Import (SCIA Engineer - Revit):

The user mapping during import, has a slightly different interface than that of the export. The columns in the user mapping table will be rearranged so that the user specifies the equivalent Revit material/family for the selected SCIA Engineer material/section.

While importing the model from SCIA Engineer, the application will read the SCIA Engineer object and find the equivalent Revit family and its types by reading through the pre-defined databases and user

tables. Once the Revit family is identified, the family and its types will be created in Revit by loading appropriate family and its type in the Revit document. The application will try and search the family files (.rfa) in the library path and the Revit family path listed in the below locations.

Revit -> File -> Options -> File locations -> Places Or
 Revit -> CADs -> CADs Revit SCIA Engineer Link -> Options -> Revit Family path

Hence, it important to specify the location of family files correctly. It is also important to choose the appropriate Revit template as the Revit materials and sections are first read from the document.

If the application couldn't find the equivalent Revit family, it will prompt you to map the Revit family and its types.

Form material mapping, the Revit materials will be listed based on the selected database. You can select the "Load All" option to load all the supporting databases.

You may skip the material, but please note that in such cases, the elements that uses the skipped materials will be ignored during import.

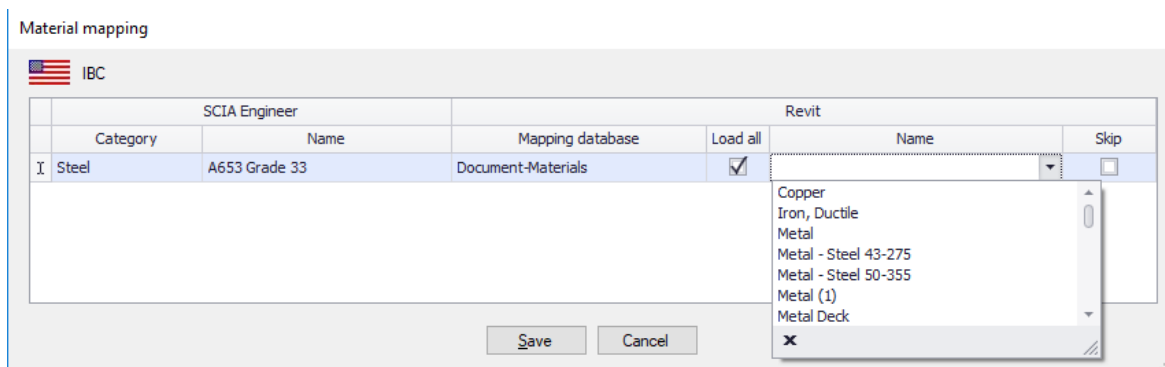

For standard steel profile sections, the group name will be shown as "Profile library". The application will identify the family name, will load the family type by reading the text file and create the members in Revit.

If the application couldn't find the Revit families, a warning sign will be shown for such sections. In such cases, you can check the "Load all" option and select the appropriate database (Revit family path) and choose the appropriate family and the family type.

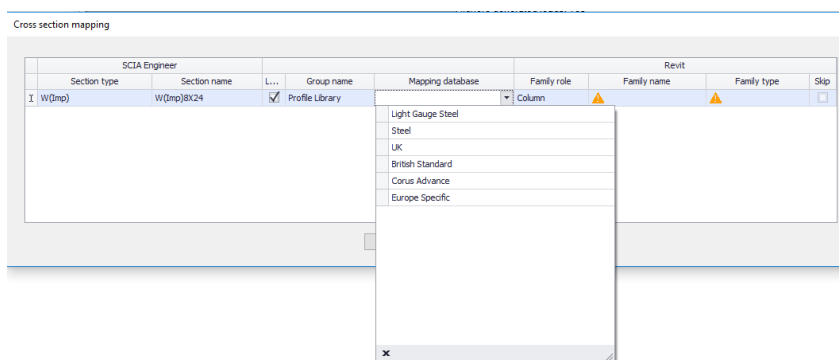

The application will list the families which are available in the selected path. The list of family types is based on the types listed in the selected family. If the user chooses the "Document –families", he will be allowed to select any of the family and its type from the document (Revit project).

While importing the sections (Concrete, Geometric, Thin-walled, Pairs, Closed, etc..) which requires the parameter mapping, the parameters needs to be mapped to create the family types. The application will try to find the equivalent family within the Revit project document and if it is not found, the application will use the pre-installed CADs families.

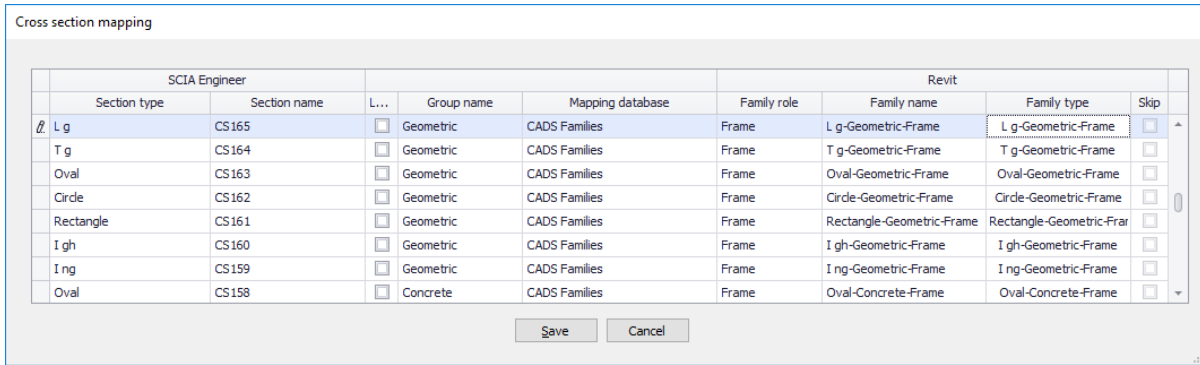

The parameters will be automatically mapped for the CADS families and some of the standard Revit families.

You could change the family to be used by using the “Load all” option and choosing the appropriate databases.

If you choose “Document families – Parametric”, then you will need to map the individual parameters between SCIA Engineer and Revit.

To summarise:

Name of Database	Action
CADS families	Mapping of the parameters is automatic; no user action is required. The types will be created according to the values.
Document families - Parametric	You need to map the parameters* once. The value of parameters will be updated and new type will be created if needed.
Document families	The user maps the family type and the family type is directly used.

*If the document families are of standard Revit families, the parameters will be automatically mapped.

(For user defined families of Build-in beams, Paired sections and closed sections alone, you will not be able map the profiles, but will need to map the dimensional properties of the section profiles with Revit parameters.)

While importing the profile sheets from SCIA Engineer, the standard profile sheets are automatically imported using the pre-installed CADS families. The user defined profile sheets can be imported by mapping them with the CADS families.

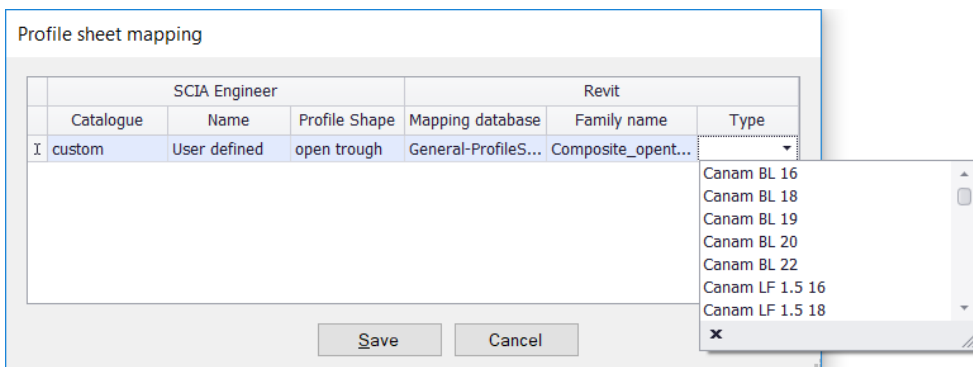

6 Import analysis results from SCIA Engineer

Results are imported from both 1D members (member) and 2D members (surfaces) from all available load cases and combinations.

The results imported include:

1. Support reactions:
 - ▶ Reactions (F_x , F_y and F_z) in global directions
 - ▶ Support moments (M_x , M_y and M_z) about global directions
2. Member results:
 - ▶ Member internal effects (F_x , F_y , F_z , M_x , M_y and M_z)
 - ▶ Member displacements (U_x , U_y and U_z)
3. Surface results:
 - ▶ Membrane forces (N_{xx} , N_{yy} and N_{xy})
 - ▶ Shear forces (Q_{xx} and Q_{yy})
 - ▶ Moments (M_{xx} and M_{yy})

(Results for surfaces are obtained using the in-nodes average option from SCIA Engineer).
4. Deformations (Deformed structure)

Import of stresses and rotations are not supported for both 1D and 2D members (members and surfaces).

Please refer to Autodesk Revit help on [Help | Assumptions for the Visualization of Analysis Results for Surface Objects | Autodesk](#) and [Help | Available Types of Results for the Static Analysis | Autodesk](#).

6.1.1 Co-ordinate system:

The global co-ordinate system and the local co-ordinate system for members (1D member in SCIA Engineer) and surfaces (2D member in SCIA Engineer) can be displayed in Revit by selecting the option in the results manager.

Revit and SCIA Engineer follow the same conventions for the Global co-ordinate system.

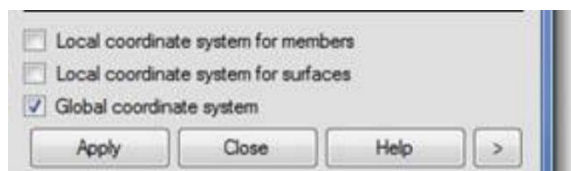

6.1.2 Importing analysis results

To enable the import of analysis results, set the input for *Analysis results* under *Import* to *Yes*.

Note that importing analysis results could take considerable time and depends upon the size of the job, number of load cases, presence of 2D members etc. Hence it is best to try with a few combinations and a reduced model initially.

For “envelope” combinations, the max and min values will be shown in Revit. If you need the combination results, explode the combinations into linear and import them into Revit.

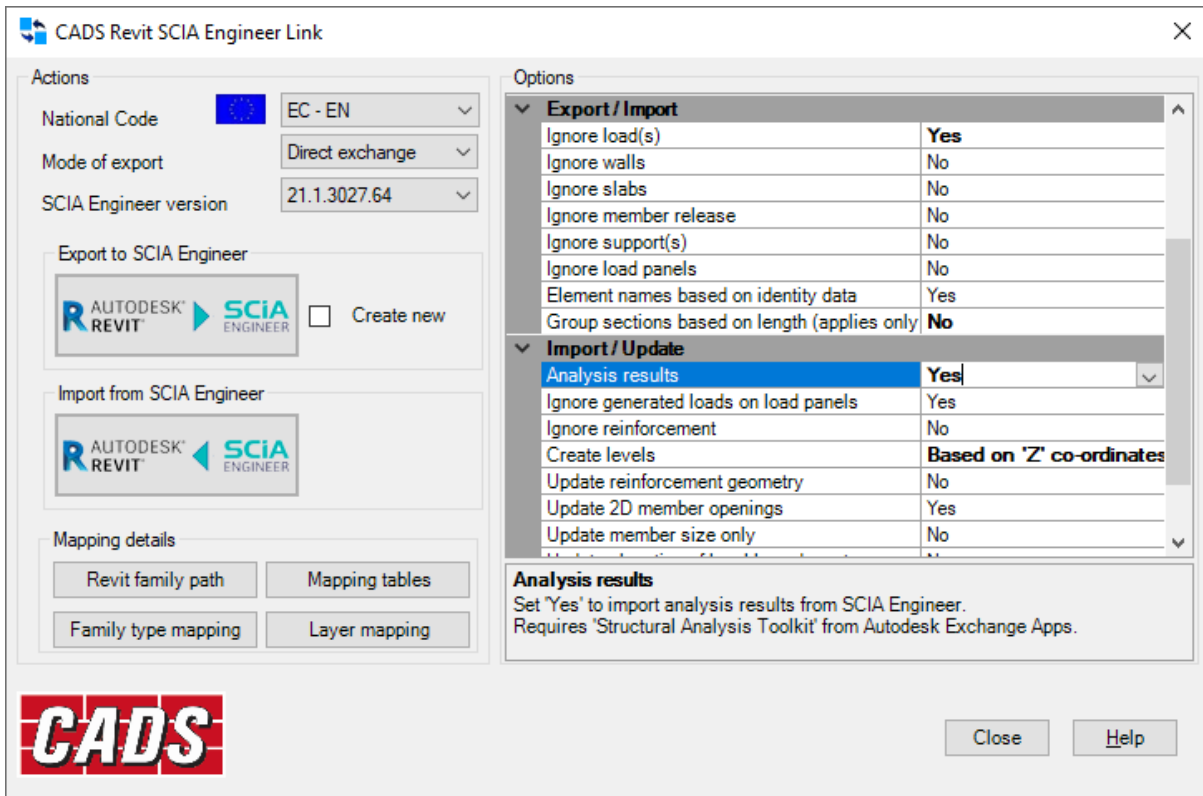

6.1.3 Viewing the analysis results

Once the import of the model is completed, click on *Results Manager* from the *Analyze* tab in the *Structural Analysis* group.

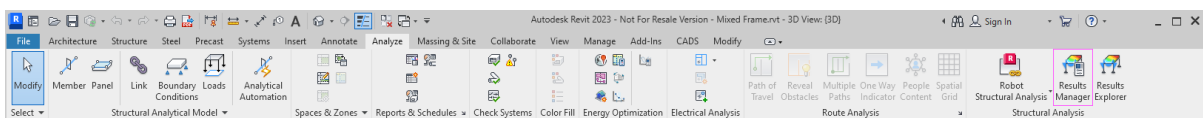

When imported with results an entry will be available in the results manager to show that the results are up-to-date along with the date and time of the import. CADs Revit SCIA Engineer Link will be displayed under the “Provider” column of the Results Manager.

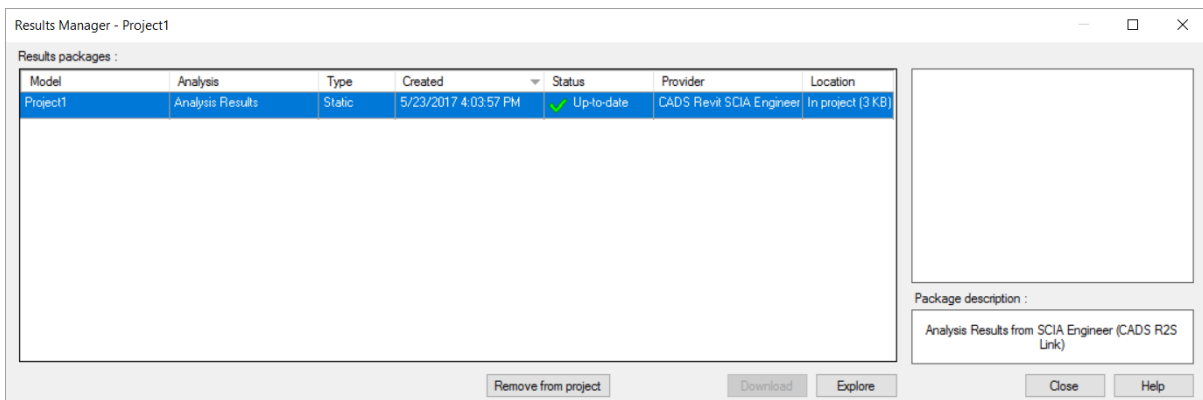

The option to view results is available in the results explorer which can be launched from the review manager by clicking on *Explore* or by directly selecting the *Results Explorer* option in the *Analyse* tab under *Structural Analysis* group.

It is recommended that you view the results on the analytical model.

It is possible to store and compare multiple sets of results from Revit. Hence the Results Explorer has options to choose the model, analysis set and load case to view the result. Load combinations are also listed.

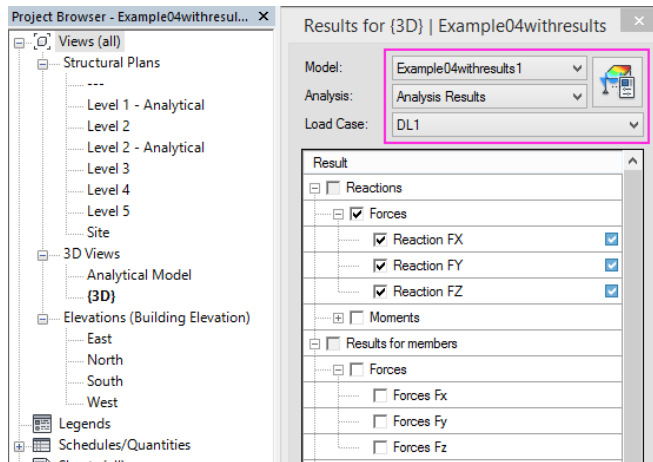

Select the required result type and click on *Apply* at the bottom of the dialog to view the result.

The load case list displays all the load cases including the ones available in Revit by default. In many cases the structural engineer may create their own load cases in SCIA Engineer rather than using the ones imported from Revit. In such cases the load cases originally created in Revit but not used in SCIA Engineer will not have any results.

The following message will be displayed on selecting those load cases for which no results are available. In this case close the message and select a load case which is used in the SCIA model.

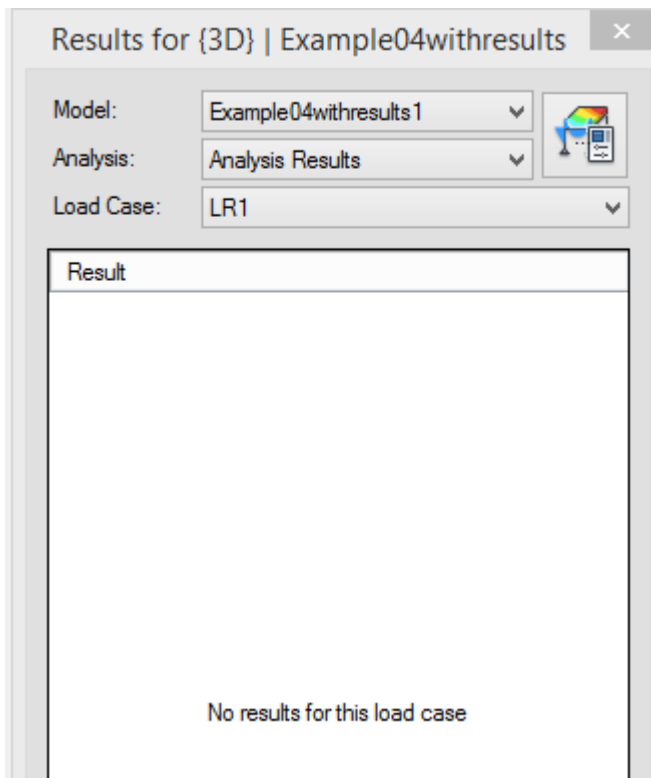

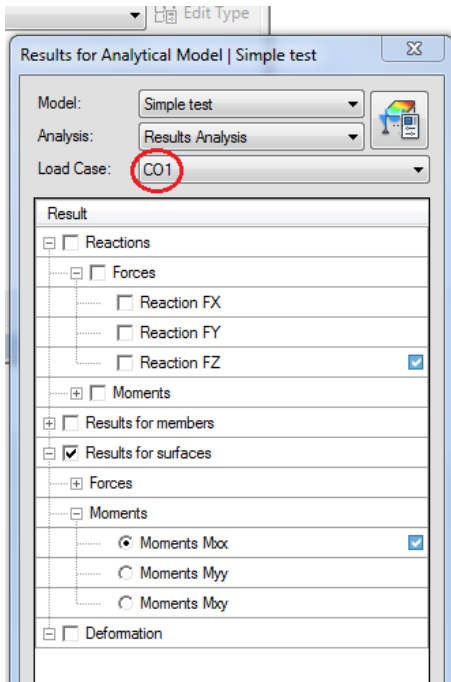

Moments Mxx (< kN-m/m >)

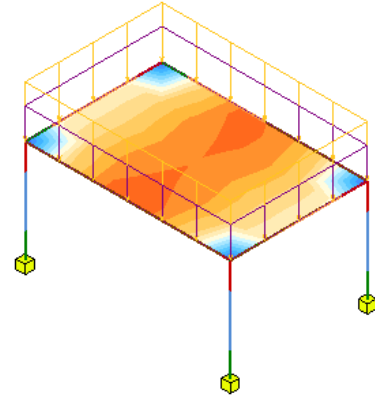
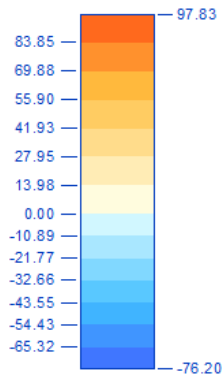

Model: Simple test
Load case: CO1

Results Analysis

For 2D members, the results from SCIA Engineer are exported using *In nodes, avg* (average) option. There is no user option to modify it.

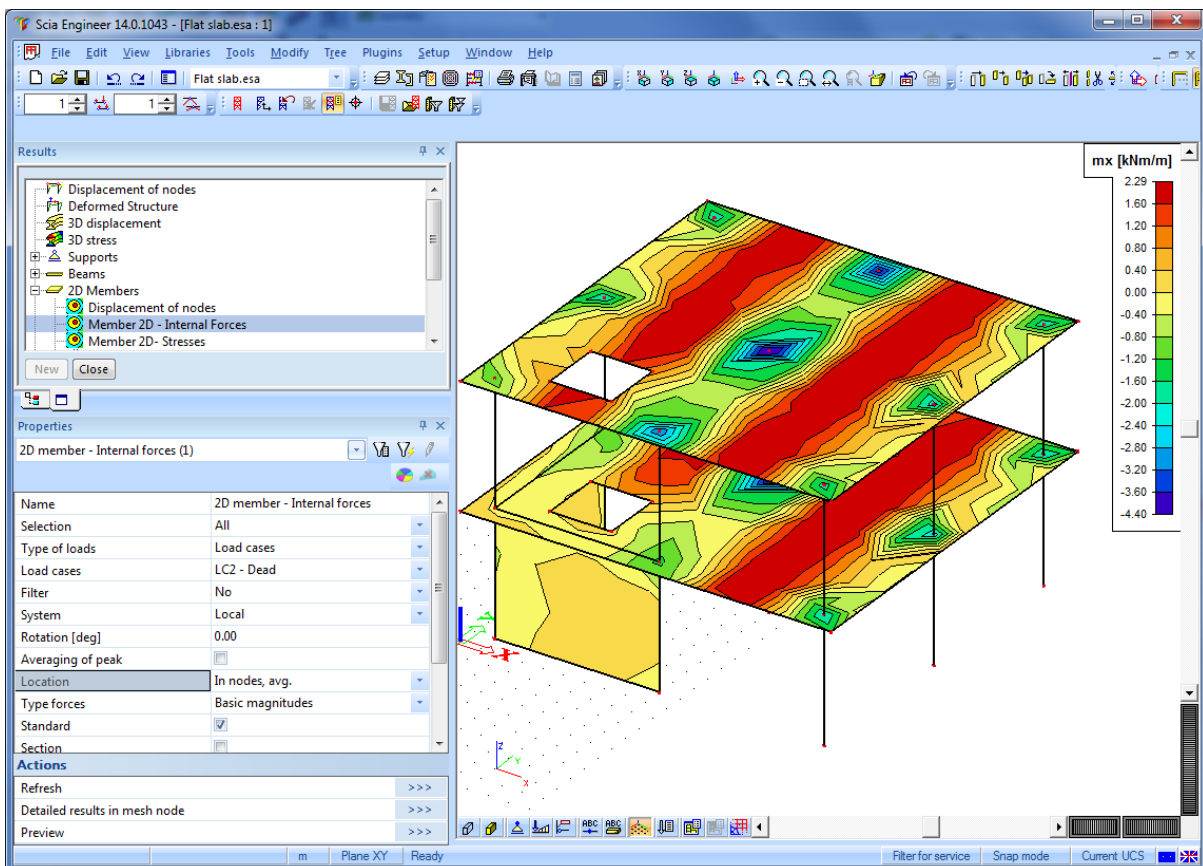

Moments Mxx (< kN-m/m >)

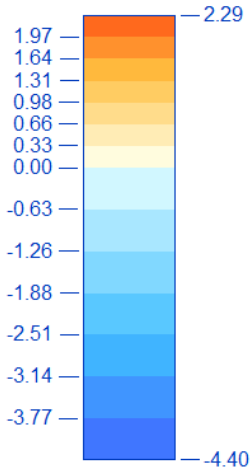

Model: Flat slab from Scia
Load case: LC2

Results Analysis

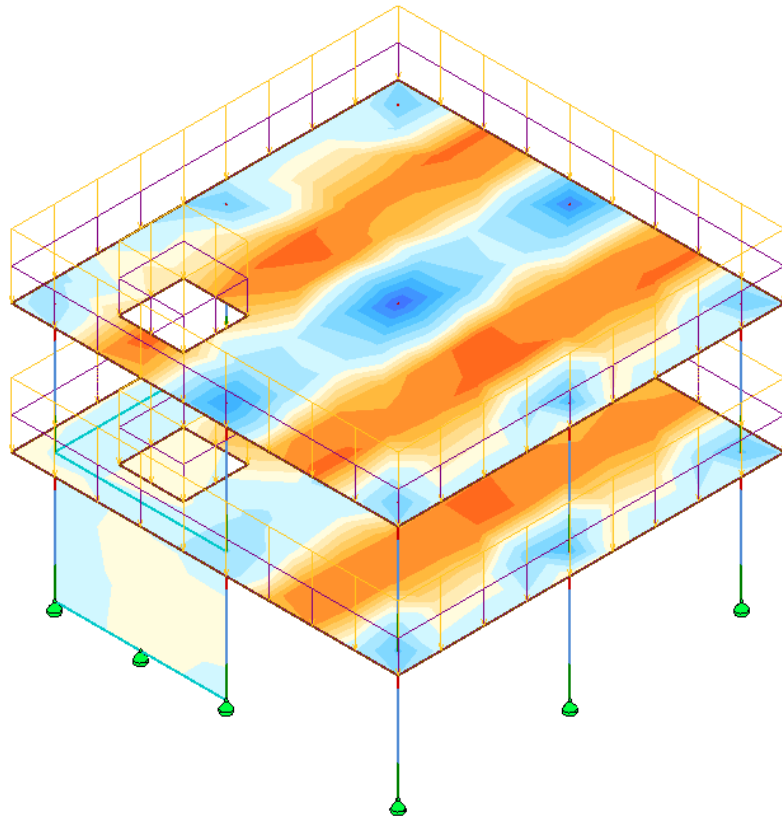

6.2 Beam reactions

On importing analysis results from SCIA Engineer, beam end reaction (shear) can be included as annotation tags. The value reported is the maximum shear (V_z) at member start and end from all the available combinations.

To add the end reactions to beam annotations:

1. Select the plan view of the Level.
2. Click **Beam Annotations** from the **Annotate** tab.

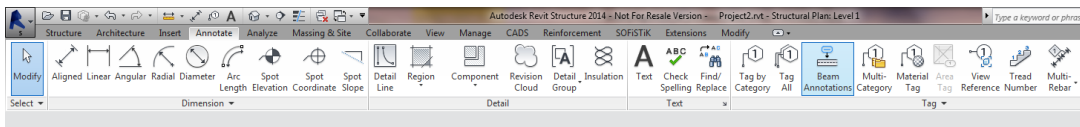

- The **Beam Annotations** dialog box is displayed.

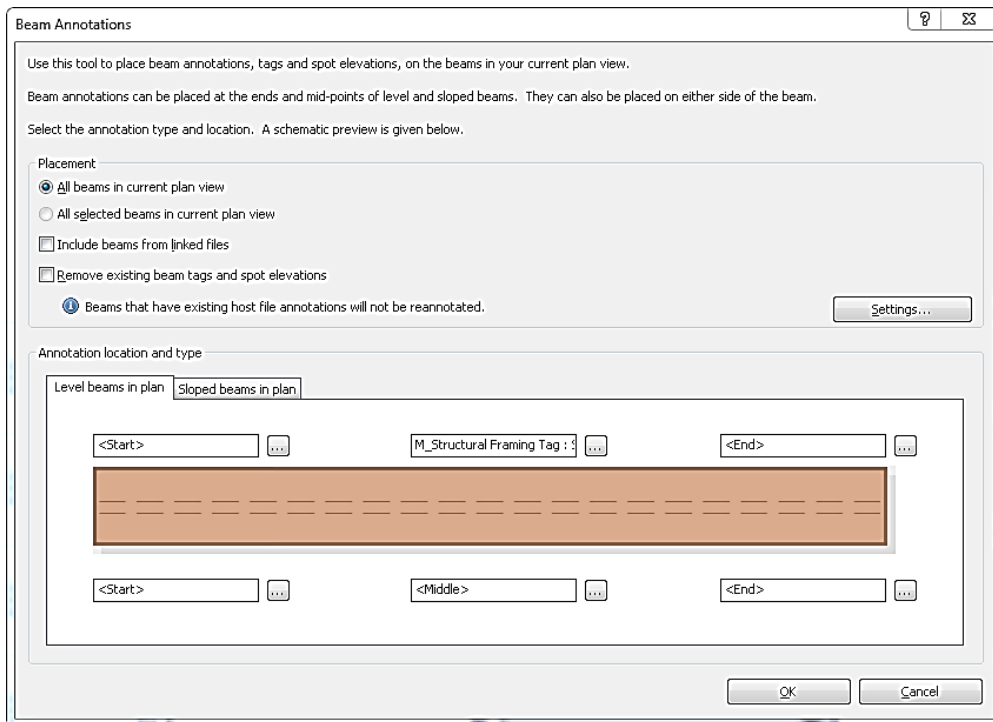

3. Click the browse button (three dots) to the right of the label name.
4. Select the **Structural Framing Tag** option.

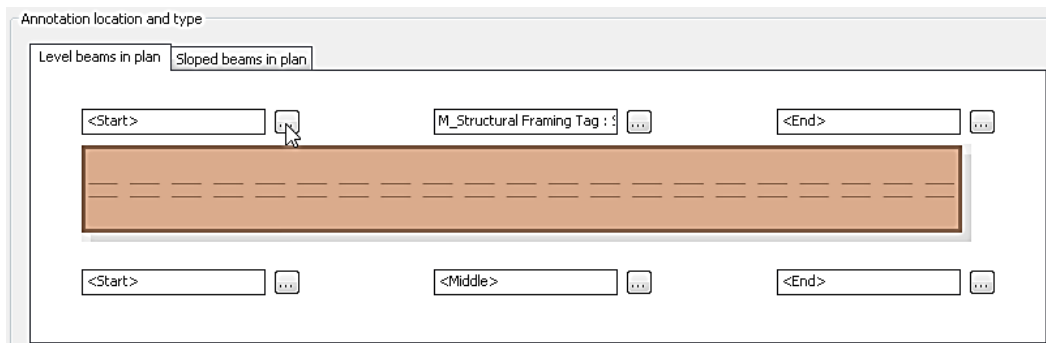

5. Select the annotation type as **Start Reaction Tag** for the start position of the beam and **End Reaction Tag** for end from the Type drop down list. The start reaction tag and end reaction tag families are loaded into the project during import.
6. Click **OK**.
7. The start and end reactions will be shown in the plan view.

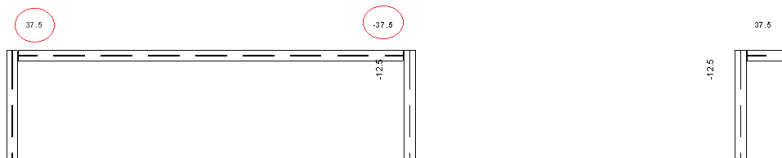

8. Click the **Options** button to specify the vertical and horizontal offset for the tag(s) in the **Placement Settings** dialog box.

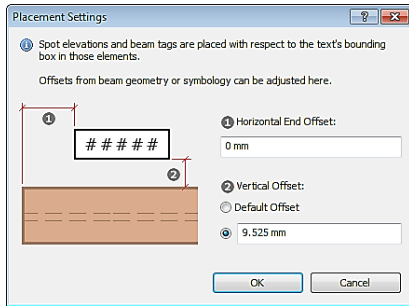

Please note, the Beam annotations can be created only in the plan view.

6.3 Importing Design info from SCIA Engineer

The design information for composite beams and virtual joists can be imported from SCIA Engineer to Revit. Composite design data includes the studs, camber, moments and shear forces at the ends of the member. For virtual joists, the joist designation, moments and shear forces at the ends of the member will be imported into Revit as properties of the members.

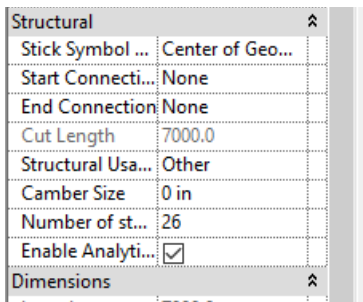

The design info (composite beam design info and virtual joist design info) is available as an attribute of the member. Studs and camber info are imported to Revit as properties of the “Structural frames”, Joist designation is imported as “comments” and moments & shear forces at ends are imported into Revit as “Member forces”. For Joist girders, in addition to above, the number of spacing and the point load will be updated in the property “SpaceNum” and the Panel point load respectively.

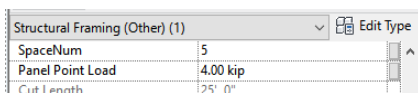

7 Round trip

7.1 Step 1 – Create the model in Revit

This example explains the round trip between Revit and SCIA Engineer.

Create the model in Revit structure as shown below.

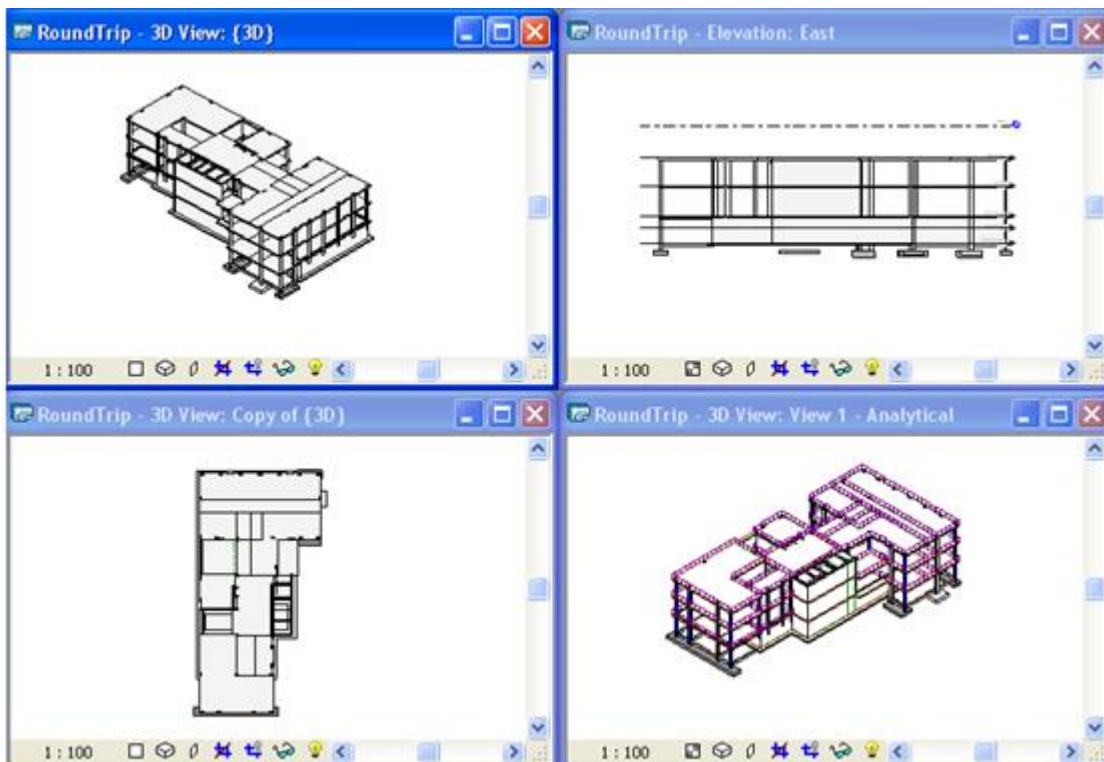
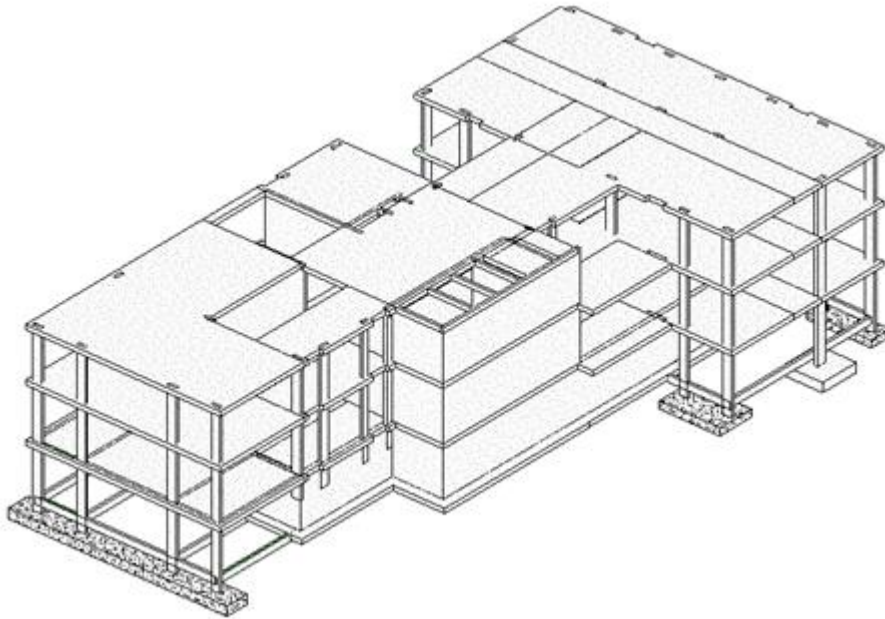

7.2 Step 2 – Export to SCIA Engineer

Export the model to SCIA Engineer using the “Export to SCIA Engineer” command. The exported model is shown below.

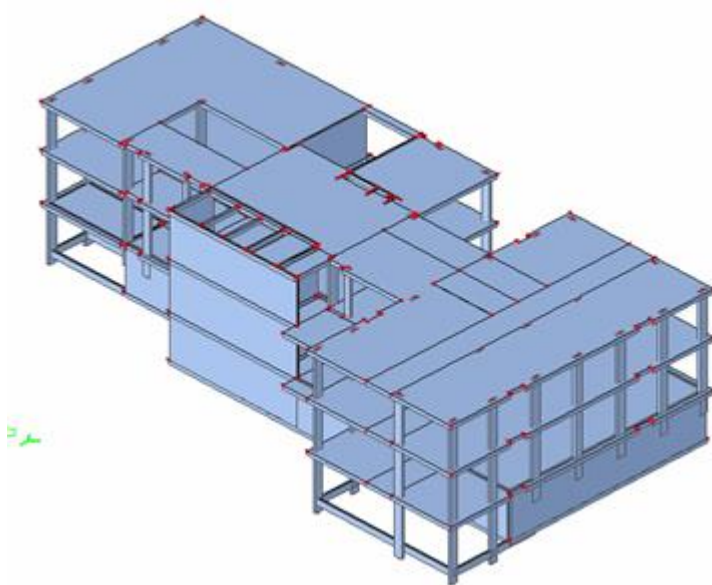
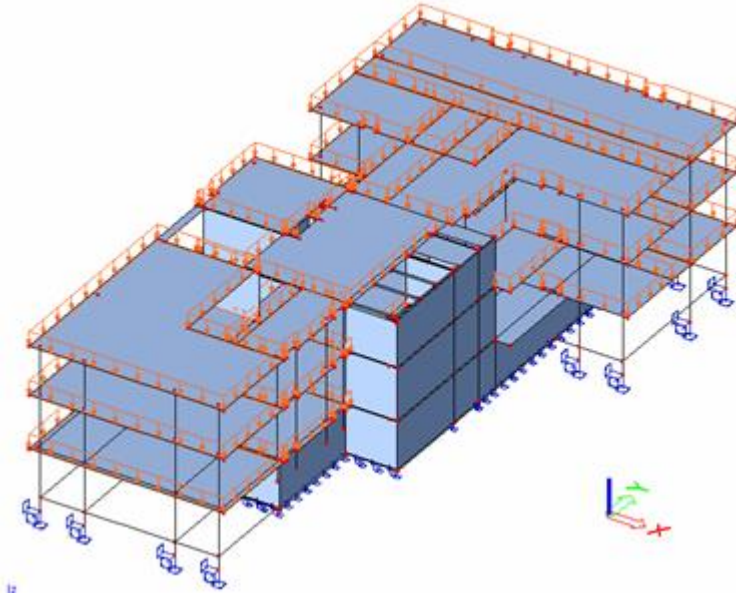

7.3 Step 3 – Analyse / Design in SCIA Engineer

Do the analysis in SCIA Engineer and optimise for size / geometry configuration etc.

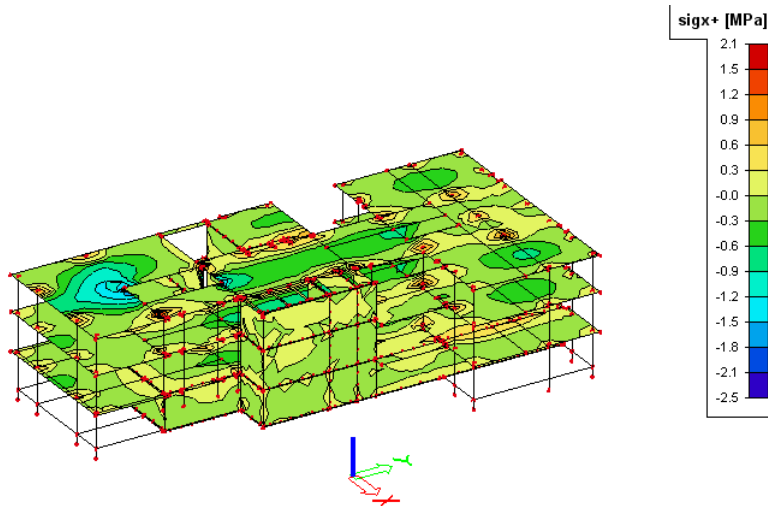
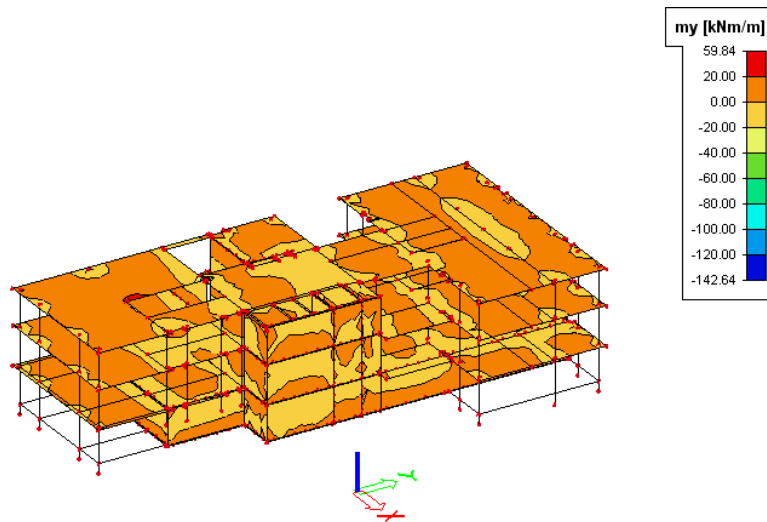

For instance, the size of the two columns shown below is reduced from 200x600 mm to 200x450 in the SCIA Engineer model.

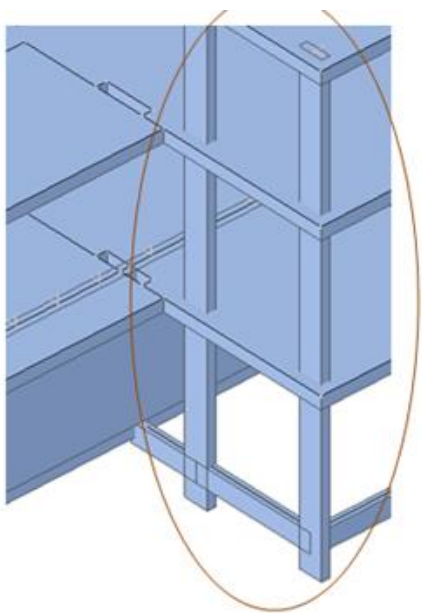

Size of the column = 200x600

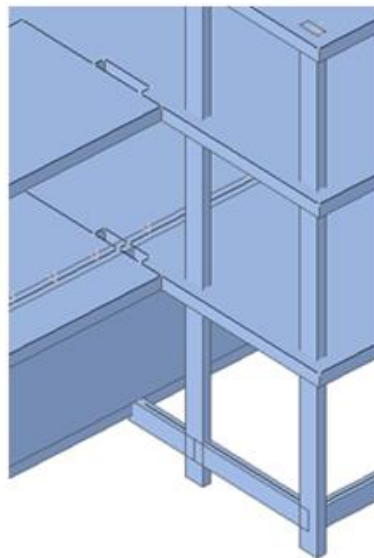

Size of the column after modification = 200x450

7.4 Step 4 – Update from SCIA Engineer

Update the model back into Revit using the “Import / Update” command.

The column sizes in Revit are shown before and after the update process.

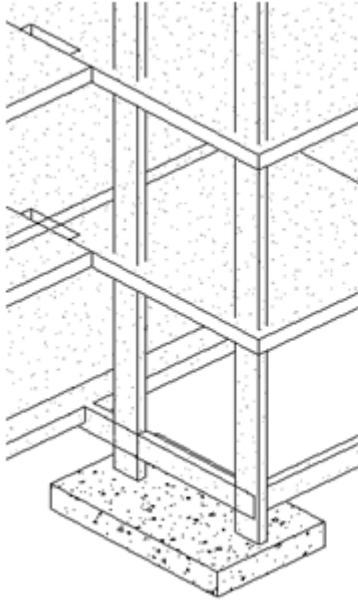

Size of column - Before updating = 200x600

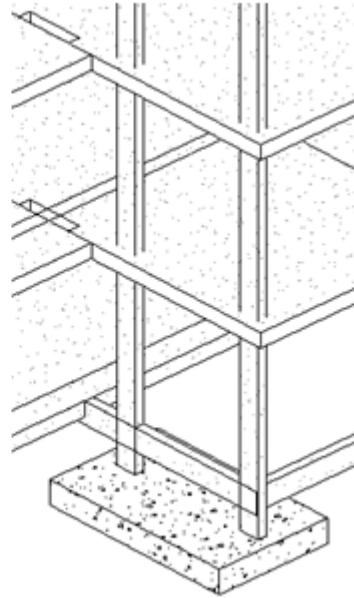

Size of column – After updating = 200x450

8 Features matrix for Revit link (Appendix)

The following table lists how the physical Revit Structural objects are transferred between Revit and SCIA Engineer:

Main items	Sub items	Revit to SCIA Engineer		SCIA Engineer to Revit		Comments
		New	Update	New	Update	
Grid		n/p	n/p	n/p	n/p	
Levels		n/p	n/p	Yes	Yes	Levels in Revit are created based on Stories/ Position of Slabs/ Z coordinates of members in SCIA Engineer.
Materials	Steel, Concrete, Timber (Euro, IBC), Masonry (Euro)	Yes	Yes	Yes	Yes	
	Timber and Masonry (BS, LRFD, NEN)	n/p	n/p	n/p	n/p	No material available in SCIA Engineer
	By Category	Yes	Yes	n/a	n/a	Material set as 'By Category' in Revit will now be exported to SCIA by mapping to an equivalent SCIA Engineer material set for each category (Concrete, Steel, Timber).
Cross-sections	Standard steel sections (Profile library)	Yes	Yes	Yes	Yes	Most of the standard families are auto mapped with the sections in SCIA Engineer. Some of the families might need user mapping.
	Pairs, Closed, Haunch, Sheet welded, Build-in beams, Thin-walled geometric sections	Yes	Yes	Yes	Yes	Revit - SCIA -> Based on user mapping (Parameters). SCIA – Revit-> Comprehensive list of CADs Families supplied with the link will be used by default. The available family files are deployed in C:\ProgramData\CADS\Revit to SCIA Engineer\Revit xxxx\Revit Families
	Concrete Sections: I ng (Asymmetric I Section), Rectangle, Circle, Oval, T g,	Yes	Yes	Yes	Yes	Revit- SCIA -> Based on user mapping (Parameter mapping).

Main items	Sub items	Revit to SCIA Engineer		SCIA Engineer to Revit		Comments
	L g, Lg (Inverted L)					
	Timber sections: Rectangle, Circle, 2 Rectangles, 3 Rectangles, T profile, Cross, 2 +1 El. Fil, I non-symmetric, I symmetric, Box	Yes	Yes	Yes	Yes	Revit- SCIA -> Based on user mapping (Parameters). SCIA – Revit->Comprehensive list of CADs Families supplied with the link will be used by default. The available family files are deployed in C:\ProgramData\CADS\Revit to SCIA Engineer\Revit xxxx\Revit Families
	General sections	n/a	n/a	Yes	Yes	The cross-section mapping with Revit family cannot be saved with the Section mapping table, but has to be mapped during the export/import process.
	Numerical sections	n/a	n/a	No	No	Numerical sections from SCIA Engineer can be imported by mapping to the Revit families.
	Precast Sections Single T (Precast 1) and Double T (Precast 2)	Yes Yes	Yes Yes	Yes Yes	Yes Yes	
	Geometric Shapes: I ng (Asymmetric I Section), I gh (I Section), Rectangle Circle, Oval, T g, L g, U g (C Section), Tube, X, Z, O, C (Box C Section), O Asymmetric	Yes	Yes	Yes	Yes	Geometric sections are created based on parameter mapping and are dependent on the materials used.
2D Members	2D Element - Ribbed Slab	n/a	n/a	Yes	Yes	Mapped as two different elements in Revit.
	Load panel	Yes	Yes*	Yes	Yes	Analytical panels with structural role “panels” can be exported as Load panels in SCIA. Load panels are imported to Revit as analytical panels and

Main items	Sub items	Revit to SCIA Engineer		SCIA Engineer to Revit		Comments
						are updated back to SCIA as load panels.
National Code	BS, EC-EN, EC-ENV, NEN (Metric) IBC, IBC (Metric and Imperial), SIA	Yes	n/a	n/a	n/a	Materials are mapped according to the National code.
Column	Rotations	Yes	Yes	Yes	Yes	Alpha rotation and Non-standard LCS rotation are not supported.
	Start/end points	Yes	Yes*	Yes	No	*Extra nodes will not be deleted in SCIA Engineer
	Analytical Alignment	Yes	Yes	n/a	n/a	Only 'Auto Detect' is supported.
	Material	Yes	Yes	Yes	Yes	
	Member end releases	Yes	Yes	Yes	Yes	
Frame	Rotations	Yes	Yes	Yes	Yes	Alpha rotation and Non-standard LCS rotation are not supported.
	Start/end points	Yes	Yes*	Yes	No	*Extra nodes will not be deleted in SCIA Engineer.
	Analytical Alignment	Yes	Yes	n/a	n/a	
	Material	Yes	Yes	Yes	Yes	
	Structural Usage	Yes	Yes	Yes	Yes	
	Member end releases	Yes	Yes	No	No	
	Z direction and Lateral Justification	Yes	Yes	Yes	Yes	Subject to Revit limitation.
Brace	Rotations	Yes	Yes	Yes	Yes	Alpha rotation and Non-standard LCS rotation are not supported.
	Start/end points	Yes	Yes*	Yes	No	*Extra nodes will not be deleted in SCIA Engineer.
	Analytical Alignment	No	No	No	No	
	Material	Yes	Yes	Yes	Yes	
	Structural Usage	Yes	Yes	Yes	Yes	

Main items	Sub items	Revit to SCIA Engineer		SCIA Engineer to Revit		Comments
	Member end releases	Yes	Yes	No	No	
Curved beams	Circular arc	Yes	Yes	Yes	No	
	Ellipse	Yes	No	No	No	
	Spline	Yes	Yes	No	No	
Truss		Yes	Yes	n/p	Yes	
Beam System		Yes	Yes	n/p	Yes	
Composite Beam	Composite beam as simple beam	Yes	Yes	n/a	Yes	
	Composite beam and slab data	No	No	No	No	
	Camber and number of studs	No	No	Yes*	Yes*	* This works only when the design info is stored with the member in SCIA Engineer
	End forces	No	No	Yes*	Yes*	
Steel bar joist	Steel bar joist	Yes	Yes	Yes	Yes	Steel bar joists are mapped as virtual joists.
	Joist designation	n/a	n/a	Yes*	Yes*	* This works only when the design info is stored with the member in SCIA Engineer. The data for SpaceNum and Panel Point load are read from the "Comments" in the Design info of SCIA Engineer.
	End forces	No	No	Yes*	Yes*	
	SpaceNum and Panel Point load	No	No	Yes*	Yes*	
2D Members - Slab	Linear, Curved Edge	Yes	Yes*	Yes	Yes [#]	*Extra nodes will not be deleted in SCIA Engineer. #Only section sizes and material property updated, change in geometry is updated back to Revit analytical panels and not for Structural floors.
	Change in number of edges	n/a	n/p*	n/a	No	*Limitation in SCIA Engineer.
	Holes Using "Edit" slab option and drawing a hole profile Rectangular, Circular, Polygon	Yes	Yes	n/a	n/a	

Main items	Sub items	Revit to SCIA Engineer		SCIA Engineer to Revit		Comments
	Holes using "opening" command Rectangular, Circular, Polygon	Yes	Yes	Yes	Yes	*Openings can also optionally be exported as panels.
	Thickness	Yes	Yes	Yes*	Yes*	*Multiple layers as Single thickness.
	Material	Yes	Yes	Yes	Yes	
	Varying thickness in several directions	n/p	n/p	n/p	n/p	No equivalent type in SCIA Engineer.
	Varying thickness in one direction	No	No	No	No	
	Out of plane arc (i.e. curved slab)	No	No	No	No	
	Sloped slab	Yes	Yes	Yes	No	
	Spline edge	Yes	Yes	Yes	Yes#	#Only section sizes and material property is updated, change in geometry is not updated back to Revit.
2D Members – Composite slab	Composite slab	Yes	Yes	Yes	Yes	
	Metal deck	Yes	Yes	Yes	Yes	
2D Members - Wall	Linear, Curved Edge	Yes	Yes*	Yes	Yes#	*Extra nodes will not be deleted in SCIA Engineer. #Only section sizes and material property updated, change in geometry is updated back to Revit analytical panels and not for Structural floors.
	Change in number of edges	n/a	n/p*	n/a	No	*Limitation in SCIA Engineer.
	Holes Using "Edit" wall option and	Yes	Yes	n/a	n/a	

Main items	Sub items	Revit to SCIA Engineer		SCIA Engineer to Revit		Comments
	drawing a hole profile Rectangular, Circular, Polygon					
	Holes using "opening" command Rectangular	Yes	Yes	Yes	Yes	
	Circular	n/p	n/p	n/a	n/a	
	Polygon	n/p	n/p	n/a	n/a	
	Thickness	Yes	Yes	Yes	Yes	
	Material	Yes	Yes	Yes	Yes	
	Out of plane arc	Yes	Yes	Yes	No	
	Stacked wall	Yes	n/p*	n/a	n/p*	*One physical wall has two FEM members
	Curtain wall	n/a	n/a	n/a	n/a	
	Stepped bottom	Yes	Yes	Yes	Yes	
Analytical panels as load panels	Outer boundary	Yes	No*	Yes	Yes	*Limitation in SCIA Engineer.
	Load panel openings – Geometry	Yes	No*	Yes	Yes	*Limitation in SCIA Engineer.
Boundary Conditions	Point boundary conditions for columns and beams	Yes	Yes	No	Yes	
	Line boundary condition for slabs	Yes	Yes	No	Yes	
	Line boundary condition for beams	No	No	No	No	
	Area boundary condition	Yes	n/a	Yes	n/a	Surface support (el. Foundation).
	Stiffness for boundary condition	Yes	Yes	No	Yes	
Reinforcement	Reinforcement – 1D	No	No	Yes	Yes*	* If the reinforcement is deleted in SCIA Engineer, updating the Revit model will not delete the reinforcement.

Main items	Sub items	Revit to SCIA Engineer		SCIA Engineer to Revit		Comments
		Yes	No	Yes	Yes*	
	Reinforcement – 1D (Practical)	Yes	No	Yes	Yes*	For the supported sections.
	Reinforcement – 2D	No	No	Yes	Yes*	
Foundations	Isolated as fixed boundary condition	Yes	n/a	n/a	n/a	
	Isolated as foundation block	Yes	Yes	n/a	n/a	
	Wall foundation as boundary condition	Yes	n/a	n/a	n/a	
	Wall foundation as foundation block	n/p	n/p	n/p	n/p	No equivalent feature in SCIA Engineer.
	Wall foundation for stepped wall	Yes	n/a	n/a	n/a	
	Slab as fixed boundary condition (usage = foundation)	Yes*	n/a	n/a	n/a	*Line or point support depending on structural element supported.
	Slab as Raft + Sub grade	Yes	Yes	n/a	n/a	It can be exported as ordinary 2D Element to SCIA Engineer.
Loads	Free point load	Yes	Yes	Yes	Yes	Only for Revit 2023
	Free line load	Yes	Yes	Yes	Yes	Only for Revit 2023
	Free area load	Yes	Yes	Yes	Yes	Only for Revit 2023
	Hosted point load on node	Yes	Yes	Yes	Yes	
	Hosted point load on 1D Member	Yes	Yes	Yes	Yes	
	Hosted point load on 2D Member	Yes*	Yes*	Yes	Yes	As a free load in SCIA. Free loads (without host) in SCIA is not exported.
	Hosted line load on 1D member/2D Member edge (Uniform/Varying)	Yes	Yes	Yes	Yes	
	Hosted line load on 1D	Yes	Yes	Yes	Yes	

Main items	Sub items	Revit to SCIA Engineer		SCIA Engineer to Revit		Comments
	member/2D Member edge - Partial					
	Hosted area load	Yes*	Yes*	Yes	Yes	
	Hosted area load - Partial	Yes*	Yes*	Yes	Yes	As patch load in SCIA. Free loads (without host) in SCIA is not exported. Partial varying loads are not supported.
	Load eccentricity	n/a	n/a	No*	No*	
	Location	Yes	Yes	Yes	Yes	
	LCS	Yes	Yes	Yes	Yes	If the LCS of the member is rotated, the direction of load might be incorrect.
Load cases	Dead, Live, Wind, Snow, Roof, Accidental, Temperature, Seismic	Yes	n/a	n/a	n/a	
	Self-weight	n/a	n/a	Yes	n/a	
	Temperature (LRFD code)	No				No equivalent feature in SCIA Engineer.
	Seismic (BS code)	No				No equivalent feature in SCIA Engineer.
Load Combination	Combinations of load cases	Yes	Yes	Yes*	Yes	*There are issues in Revit API, therefore to retain the load combinations SCIA Engineer does not export load combinations from Revit.
	Combinations of combinations	No	No	No	No	No equivalent feature in SCIA Engineer.
Rigid arm/Analytical links	Rigid arm/Analytical link	Yes	Yes	Yes	Yes	Analytical links in Revit are exported as Rigid arms and vice versa.
Deleting of members		Yes	Yes	Yes	Yes	
Partial selection		Yes	Yes	No	No	
Moving elements		Yes	Yes	Yes*	Yes*	*Limitation with SCIA Engineer "Move" operation. 2D members are not supported.

Main items	Sub items	Revit to SCIA Engineer	SCIA Engineer to Revit	Comments
				<p>Truss members & Beam Systems are not supported, but the member locations get updated automatically in Revit if they rest on columns due to Revit constraints.</p> <p>Default Revit error message is displayed when the column is moved in SCIA Engineer but not the members constrained to the column.</p>

Legend	
n/a →	Not applicable
n/p →	Not possible
Yes →	Implemented
No →	Not implemented

9 Technical Support

▶ Computer and Design Services Ltd

Arrowsmith Court

10 Station Approach

Broadstone

Dorset BH18 8AX

Tel. +44 (0)1202 603031

E-mail support@cads.co.uk

▶ SCIA NV

Corda 2

Kempische Steenweg 309/0.03

BE-3500 Hasselt

BELGIUM

Telephone: +32 11 948610

E-mail: info@scia.net

▶ SCIA NEDERLAND B.V.

Goeman Borgesiuslaan 77

3515 ET Utrecht

NETHERLANDS

Tel: +31 26 320 1230

E-mail: info@scia.net

▶ SCIA CZ, s.r.o.

Evropská 2591/33d

Praha 6

CZECH REPUBLIC

CZ-160 00

Tel: + 42 226 205 600

E-mail: info@scia.net