



# TUTORIAL

## STEEL FRAME

All information in this document is subject to modification without prior notice. No part of this manual may be reproduced, stored in a database or retrieval system or published, in any form or in any way, electronically, mechanically, by print, photo print, microfilm or any other means without prior written permission from the publisher. SCIA is not responsible for any direct or indirect damage because of imperfections in the documentation and/or the software.

© Copyright 2024 SCIA nv. All rights reserved.

## Table of Contents

<b>Table of Contents .....</b>	<b>3</b>
<b>General information.....</b>	<b>5</b>
<b>Welcome.....</b>	<b>5</b>
<b>SCIA Engineer support.....</b>	<b>5</b>
<b>Website.....</b>	<b>5</b>
<b>Introduction.....</b>	<b>6</b>
<b>Chapter 1: Getting started.....</b>	<b>7</b>
<b>1.1. Starting SCIA Engineer .....</b>	<b>7</b>
<b>1.2. Starting a new project .....</b>	<b>7</b>
<b>Chapter 2: Project management.....</b>	<b>9</b>
<b>2.1. Save, Save as, Close and Open.....</b>	<b>9</b>
2.1.1. Saving a project .....	9
2.1.2. Closing a project .....	9
2.1.3. Opening a project .....	9
2.1.4. Start project manager .....	9
<b>2.2. Components of the User Interface .....</b>	<b>10</b>
2.2.1. Main menu .....	10
2.2.2. SCIA Spotlight.....	10
2.2.3. Status Bar .....	10
2.2.4. Process Toolbar.....	11
2.2.5. View Bar.....	11
2.2.6. Properties Panel .....	12
2.2.7. Input Panel.....	12
<b>Chapter 3: Geometry input.....</b>	<b>14</b>
<b>3.1. Input of the geometry .....</b>	<b>14</b>
3.1.1. Cross-sections .....	14
3.1.2. Geometry .....	16
3.1.3. Additional data .....	24
3.1.4. Check structure.....	31
3.1.5. Graphic representation of the structure .....	32
<b>Chapter 4: Loads and combinations.....</b>	<b>34</b>
<b>4.1. Load cases and load groups .....</b>	<b>34</b>
<b>4.2. Load panels .....</b>	<b>36</b>
<b>4.3. Loads.....</b>	<b>37</b>
<b>4.4. Combinations .....</b>	<b>41</b>
<b>Chapter 5: Analysis .....</b>	<b>42</b>
<b>5.1. Linear analysis .....</b>	<b>42</b>

<b>Chapter 6: Results .....</b>	<b>44</b>
<b>6.1. Reactions .....</b>	<b>44</b>
<b>6.2. Internal forces .....</b>	<b>45</b>
<b>6.3. 3D deformations .....</b>	<b>47</b>
<b>6.4. Results-related status bar options .....</b>	<b>48</b>
<b>Chapter 7: Code checks .....</b>	<b>49</b>
<b>7.1. Buckling parameters .....</b>	<b>49</b>
<b>7.2. Steel code check .....</b>	<b>51</b>
7.2.1. ULS check .....	51
7.2.2. SLS check .....	54
<b>Chapter 8: Steel connections .....</b>	<b>55</b>
<b>8.1. Structural model .....</b>	<b>55</b>
<b>8.2. Steel connection .....</b>	<b>56</b>
<b>Chapter 9: Report .....</b>	<b>59</b>
<b>9.1. Engineering report .....</b>	<b>59</b>
9.1.1. Adding images to the report .....	60
9.1.2. Displaying results .....	62
9.1.3. Printing or exporting the report .....	63

## General information

### Welcome

Welcome to the SCIA Engineer Tutorial – Steel Frame. SCIA Engineer is an integrated, multi-material structural analysis and design software for all kinds of structures. Its wide range of functionality makes it deployable for any construction type: design office buildings, industrial plants, bridges, or any other project, all within the same easy-to-use environment.

The program treats the calculation of 2D/3D frameworks, design and check of reinforcement included. Besides frames, it is also possible to dimension plate structures, inclusive of advanced concrete calculations. The complete process of calculation and design has been integrated in one program: input of the geometry, input of the calculation model (loads, supports ...), linear and non-linear calculation, output of results, reinforcement design and checks according to various codes, generating the calculation report, etc.

System requirements to run SCIA Engineer 24:

<https://www.scia.net/en/support/faq/scia-engineer/installation/system-requirements>

SCIA Engineer is available in two different versions:

- Licence version  
The licence version of SCIA Engineer is secured with a Cloud account. For more information: <https://eu-1.cdn77-storage.com/scia-supportstore/support/sciaengineer/installation/24/MAN%20%5BEng%5D%20SCIA24.0%20-%20Installation%20manual%20cloud.pdf>  
SCIA Engineer is modular and consists of various modules. The user chooses from the available modules and composes a custom design program, perfectly tuned to his needs.  
In the general product overview of SCIA Engineer you will find an overview of the different modules or module editions that are available.  
A Cloud licence is also available for “Try-out”, which only limitation is in the output.
- Student version  
The student version has the same possibilities as the licence version for all of modules. This version is also secured by a Cloud protection.  
The output contains a watermark “Student version”. Projects that are stored in the student version cannot be opened in the licence version.

### SCIA Engineer support

You can contact the SCIA Engineer support service

- By e-mail  
Send an e-mail to [support@scia.net](mailto:support@scia.net) with a description of the problem and the concerning \*.esa file and mention the number of the version you are currently working with.
- By telephone  
For various phone numbers to different offices visit our page <https://www.scia.net/en/contact/offices>  
The contact by telephone is available only for users with Licence version or Try-out version

### Website

Link to Link to Manuals and Tutorials: <https://www.scia.net/en/support/tutorials-manuals>

Link to Web help: <https://help.scia.net/>

## Introduction

This tutorial describes the basic functions of SCIA Engineer for the input, analysis and design of a 3D steel frame.

Before you start, you must be familiar with your operating system: for instance working with dialogues, menu bars, toolbars, status bars, handling the mouse, etc.

First, we will explain how to create a new project and how to setup your structure. After the geometry and load input, the structure will be calculated and the results can be viewed.

Next, we will discuss the input of the buckling parameters and we will perform the steel check, the profile optimization and create a steel connection.

The tutorial ends with a brief introduction to the engineering report.

The figure below shows the calculation model of the structure that we will design.

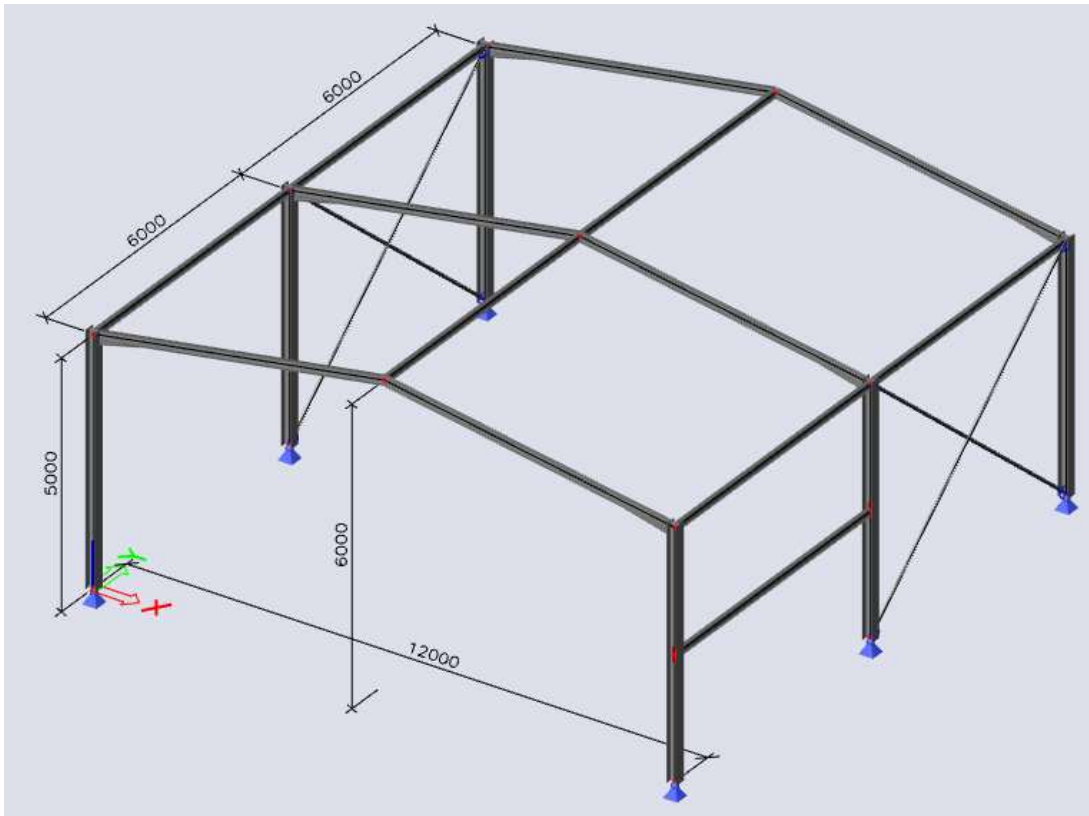

## Chapter 1: Getting started

### 1.1. Starting SCIA Engineer

Before you can start a project, you need to start the program first.

- double-click on the **SCIA Engineer shortcut** in the Windows Desktop, or
- if the shortcut is not installed, click the **Windows start button** and choose **SCIA Engineer 24.0 > SCIA Engineer 24.0**.

If the program doesn't find any protection, you will see a dialogue indicating that no protection was found. You can run the Protection setup to login with your cloud licence credentials.

### 1.2. Starting a new project

When the **Project manager** dialogue appears, click **New project**.

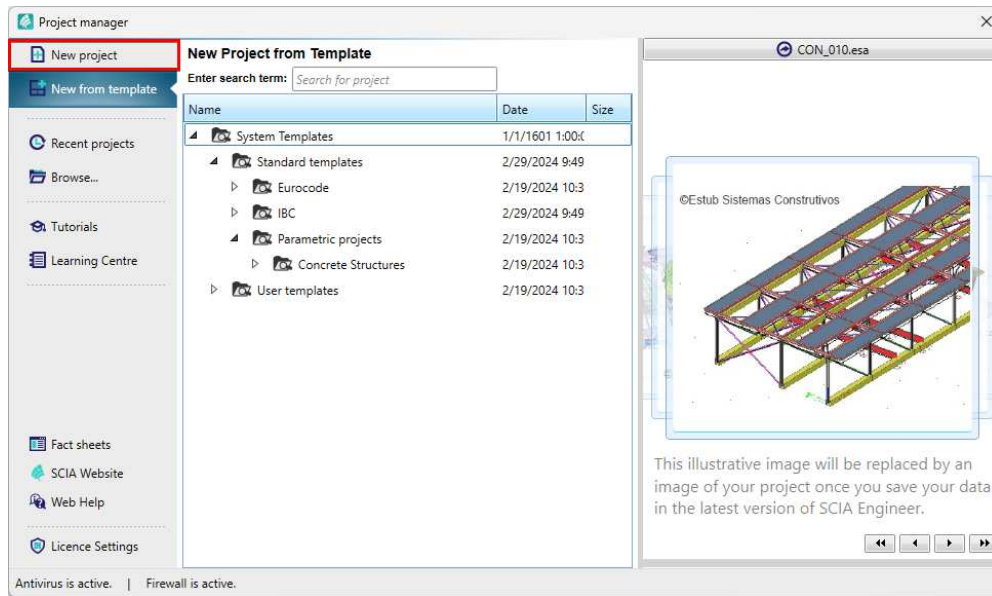

You can also start new project via **Main menu > File > New** or with the default hotkey combination **Ctrl+N**.

Now, the **Project settings** dialogue is opened. On the **Basic data** tab, you can enter general data about the project.

The screenshot shows the 'Project data' dialog box with the 'Basic data' tab selected. The dialog is divided into three main sections: DATA, MATERIAL, and CODE. The DATA section contains fields for Name, Part, Description, Author, and Date (22/07/2024), and a Structure dropdown set to 'General XYZ'. The MATERIAL section has checkboxes for Concrete, Steel (checked), Masonry, Aluminium, Timber, Steel fibre concrete, and Other. The CODE section has dropdowns for National Code (EC - EN) and National annex (Standard EN). The dialog also features an 'OK' button and a 'Cancel' button at the bottom right.

In the **Data** frame, enter your preferred data. These data can be mentioned on the output (for example in the report and on drawings).

Set **Structure: Frame XYZ** (to limit input possibilities to 1D members in 3D plane only) or **General XYZ**.

In the **Material** frame, tick the **Steel** checkbox (defining a material is the only required setting to proceed). Choose **S 235** from the combo-box.

In the **Code** frame select **National Code EC-EN** and **National annex: Standard EN**.

Confirm your input with **[OK]** button.

*Note: on the **Functionality** tab, you choose the options you need. The non-selected functionalities will be filtered from the menus, thus simplifying the program.*



## Chapter 2: Project management

### 2.1. Save, Save as, Close and Open

Before entering the construction, we first discuss how to save a project, how to open an existing project and how to close a project. When running a project of this tutorial, the project can be saved at any time. That way you can leave the program at any time and resume the project from there afterwards.

#### 2.1.1. Saving a project

Go to **Main menu > File > Save** or press **Ctrl+S**.

If a project has not yet been saved, the dialog box **Save as** appears. Choose the drive you want to save your project in. Select the (sub)folder in which you want to put the project. Enter the file name in **File name** and click on **[Save]** to save the project.

If you choose **File > Save as** in the main menu, you can select the drive and (sub)folder and set a name for the project file.

*Note: the Autosave function creates a backup file every 15 minutes by default. These projects can be found in folder C:\Users\\*username\*\Documents\ESA24.0\Autosave\*

#### 2.1.2. Closing a project

To close a project, choose **Main menu > File > Close Project**, press **Ctrl+F4** or click the **X** button above the SCIA Spotlight in the top-middle of the application.



A dialogue box appears asking if you really want to save the project. Depending on your choice, the project is saved and the active dialogue is closed.

#### 2.1.3. Opening a project

Click **Main menu > File > Open** or press **Ctrl+O** to open an existing project.

A list with projects appears. Select the desired project and click **[OK]** (or double-click on the project to open it).

#### 2.1.4. Start project manager

Click on **Main menu > File > Project browser** to open the project manager. Here the recently closed project can be found, as well as sample projects.

## 2.2. Components of the User Interface

### 2.2.1. Main menu

The Main menu is the component that will guide you through all the parameters of the project. The main features are:

- It contains functions, results & checks
- Commands shown with hotkeys
- Single letter hotkeys are allowed
- You can populate the Process toolbar by commands from the main menu – simply drag it

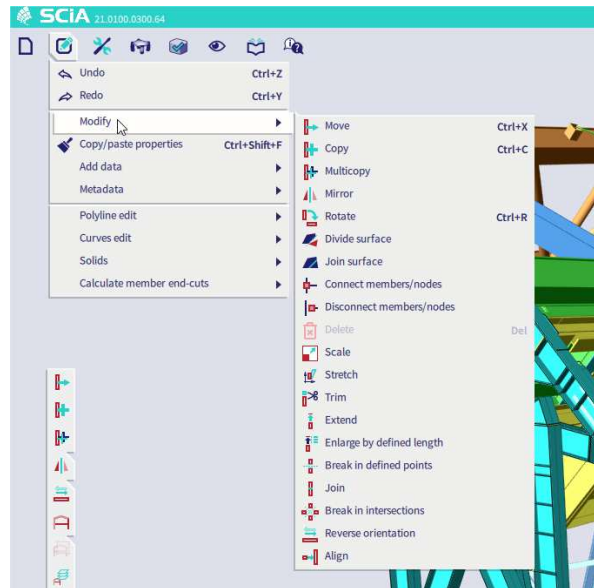

### 2.2.2. SCIA Spotlight

The SCIA Spotlight is the command line of the interface, and it has the following features:

- Autofill function
- Hotkey “Space” to set focus
- Insert coordinates or lengths (while using guiding lines)
- Fulltext search, results listed in order of priority
- Shows icons and hotkeys, same as in the menu
- “Show me” function to show position of commands in menu
- Go to webhelp option
- Drag searched command to populate the Process toolbar

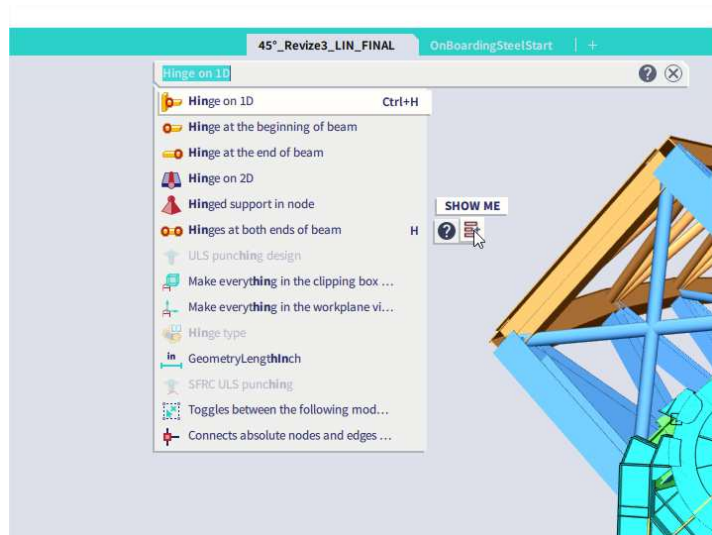

### 2.2.3. Status Bar

The Status bar allows the settings and toggles of most often used options

- Select the active load case
- Snapping and UCS settings
- Result lock, Grid lock and Autorefresh
- Codes and annexes management

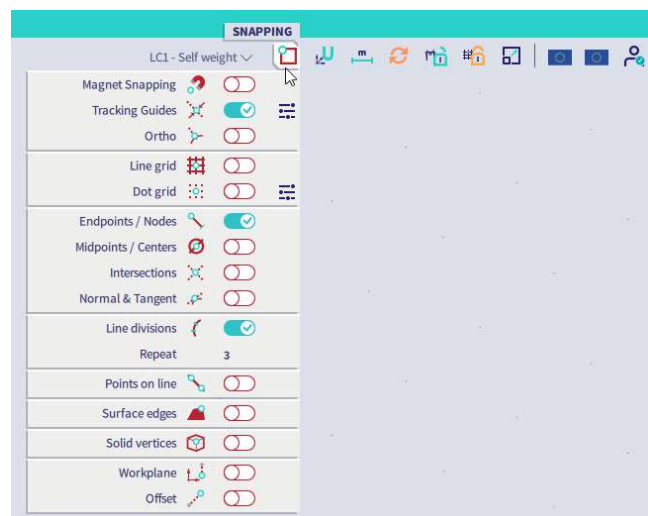

### 2.2.4. Process Toolbar

The Process toolbar has following features:

- Fully customizable panels
- Available up to 8 opened workstations selectable by you based on your project
- Have up to 2 separate toolbars open
- Additional subpanels (“stacks”) may be used to save space
- Interact with the toolbars simply by drag and drop. Drag in commands from menu, SCIA Spotlight or status bar.

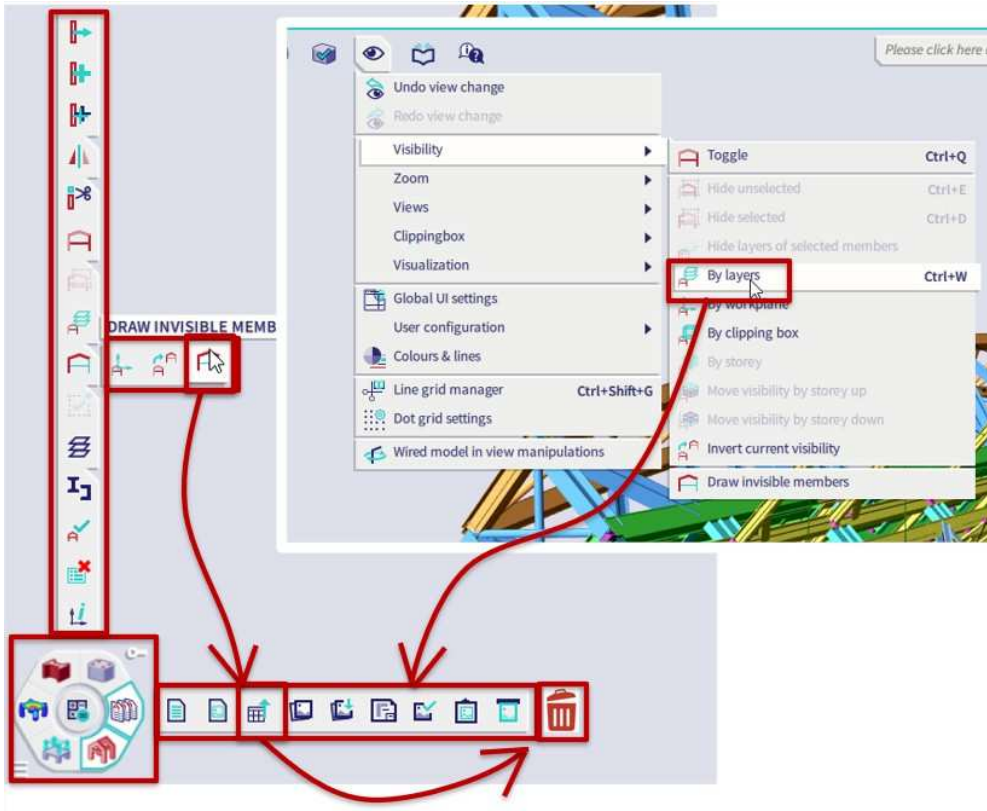

### 2.2.5. View Bar

The View bar has following features:

- View Management
  - Navicube
  - View toolbar
- Management of View parameters
  - Rendering and volumes toggle
  - Draw additional data as Supports and Loads, Labels of nodes and elements, ...
  - Additional settings available on hover (pick visible Load cases)
  - Access all the settings for all entity type

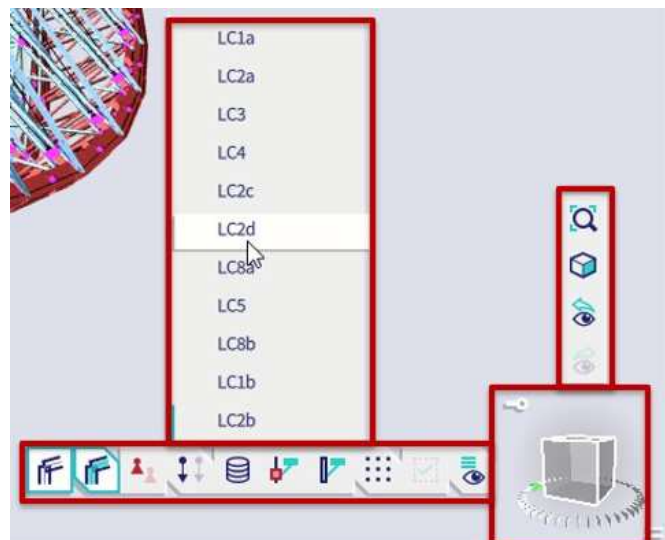

### 2.2.6. Properties Panel

The Properties panel has following features:

- Show associated data of the objects (show hinges when beam is selected)
- Contain all properties, illustrations, action buttons
- Possibility to use simplified view on the most important properties
- Manipulate with the selection (right click):
  - Add elements that share some properties into the selection
  - Isolate elements base on a property they share or based on entity type
  - Remove some elements from selection

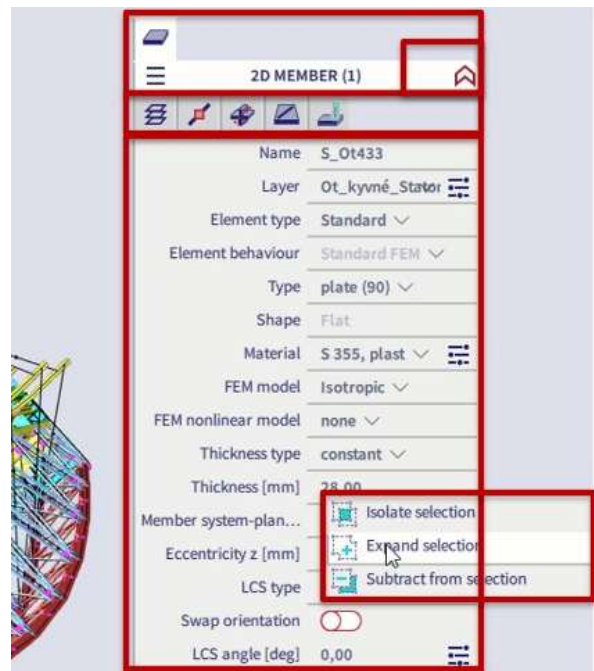

### 2.2.7. Input Panel

The Input panels contains:

- Tools to create anything
  - Everything what may be inputted is here
  - Sorted in Workstations: Structure, Load, Dynamics,..
- Filters by Categories or tags
  - Possibility to have one workstation or multiple at the same time
  - Tags are new concept to filter based on context of the project
  - Work with all tools or only with the most common ones
- Dual mode of display
  - Mode with names and hotkeys (consistent look and feel with the Menu)
  - Icon only mode

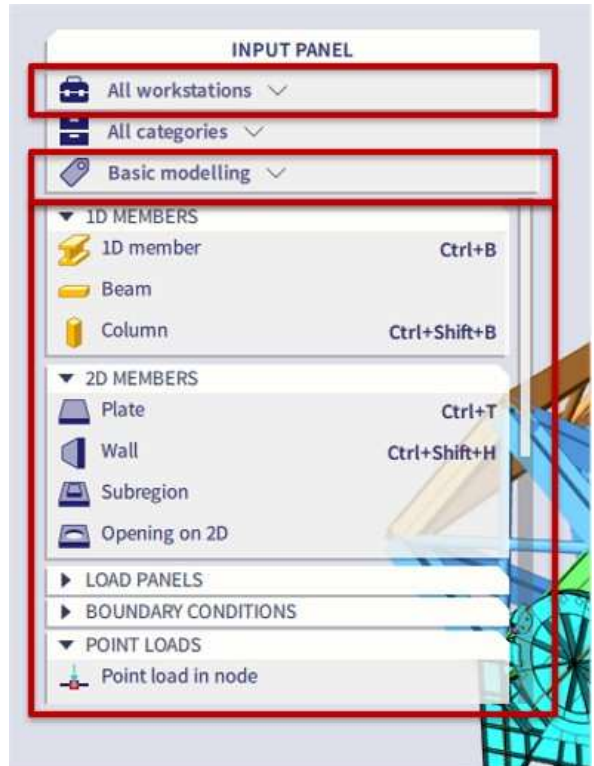

## 2.2.8. Marking menu

The Marking Menu is an invisible menu which you can call for at any location by holding ALT and clicking on the right mouse button.



By hovering over the 4 submenus you can access SCIA's most basic functions:

- Model:
  - 1D member
  - Column
  - Plate
  - Panel with load to 1D & edges
  - Hinge on 1D
  - Support in node
  
- Modify:
  - Move
  - Copy
  - Multicopy
  - Break in defined points
  - Connect members/nodes
  - Disconnect members/nodes
  
- Load:
  - Point load in node
  - Point load on 1D
  - Line load on 1D
  - Line load on 2D edge
  - Surface load on 2D
  - Free surface load
  
- Visibility:
  - Hide selected
  - Hide unselected
  - Make layers visible

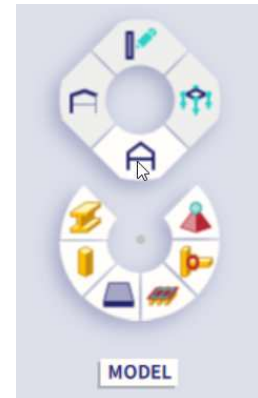

## Chapter 3: Geometry input

### 3.1. Input of the geometry

If you start a new project, the geometry of the structure must be entered. The structure can be entered directly, but you can also use for instance templates with parametric blocks, DXF files, DWG files and other formats.

#### 3.1.1. Cross-sections

When entering one or more 1D members, a cross-section is immediately assigned to each member. By default, the active cross-section is represented. You can open the profile library to activate another cross-section. If you want to add a member before a cross-section has been defined, cross-section IPE240 will be used automatically.

#### Adding a cross-section

Go to **Main menu > Libraries > Cross sections** (or with the icon in the **workstation Structure**).

The cross-sections manager is opened. If no cross-sections have been entered in the project yet, the **New cross-section** window will be automatically opened.

Click **Profile library** in the group **Available groups**.

In the **Available items of this group**, you can choose for an **I profile**. Choose **HE200A** from the list.

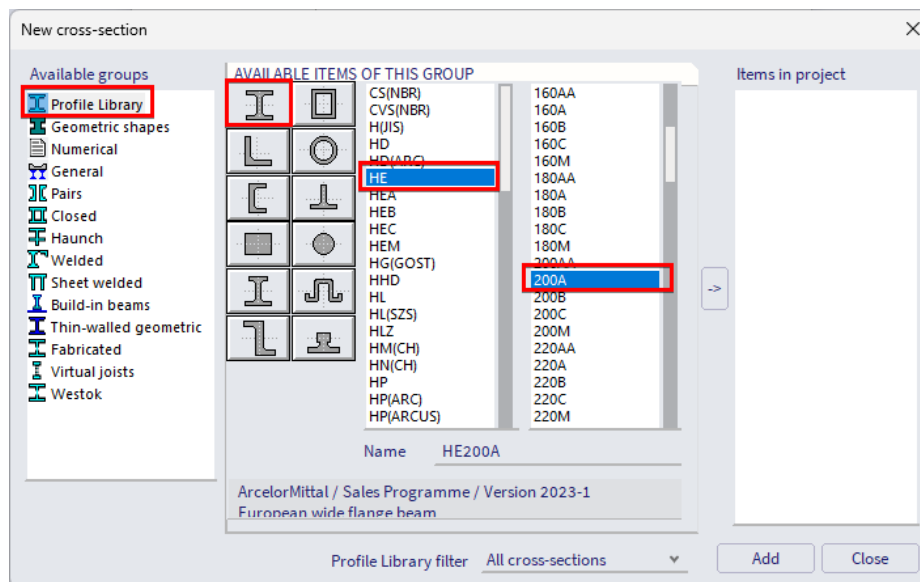

Click **Add** or the arrow-button to add the cross-section to the project.



The **Cross-section** window appears.

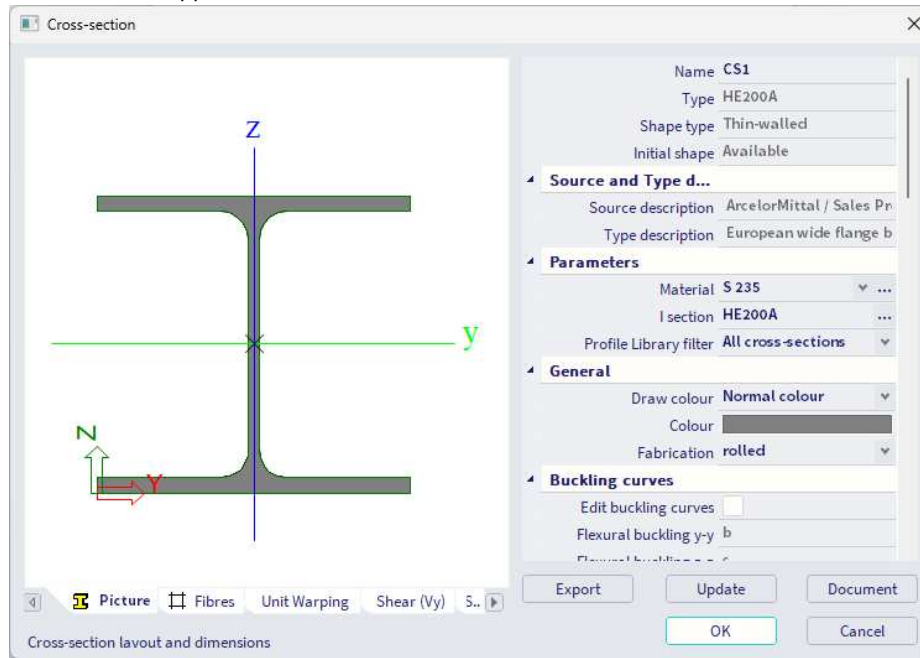

Click **[OK]** to confirm, the cross-section is now added to the cross-section list in your project. Add **IPE180** and **IPE160** in a similar way.

In the **Available items for this group**, you can choose an **angle section** (just below the I profile group). Choose **HFLeq 70x70x7** from the list.

Click **[Add]** or to add the profile to the project. Click **[OK]** to confirm.

Click **[Close]** in the **New cross-section** window, the **Cross-Sections manager** appears.

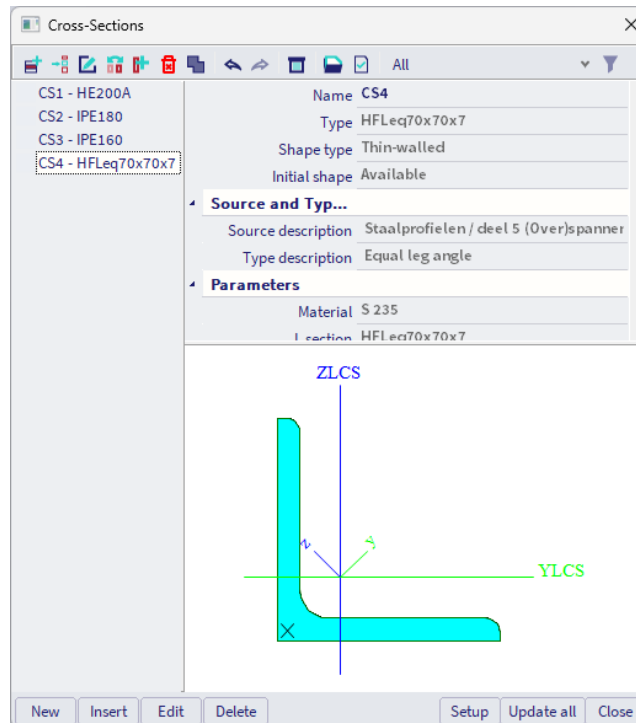

Click **[Close]** to close the **Cross-Sections manager** and to return to the graphical scene.

### 3.1.2. Geometry

In the **Input panel** we can select the **workstation Structure** to choose from different structural element types to enter the structure.



To model the structure, you must enter the first frame. Then, this frame will be copied and the wind bracings and the horizontal beams will be added.

#### Catalogue blocks

You can use single columns and beams to enter the frame., but SCIA Engineer offers as well multiple **Catalogue blocks**, allowing for a smooth and simple input of the structure.

To enter a new frame, use the option **Catalogue Blocks** in the **category Import & Blocks** of the **workstation Structure**.

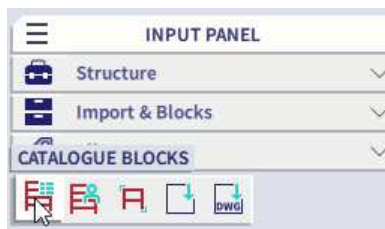

The **Block selection manager** is opened. Under **Available groups** choose the first option **Frame 2D**. In the **Available items of this group** you can choose the first shape, **Frame**.

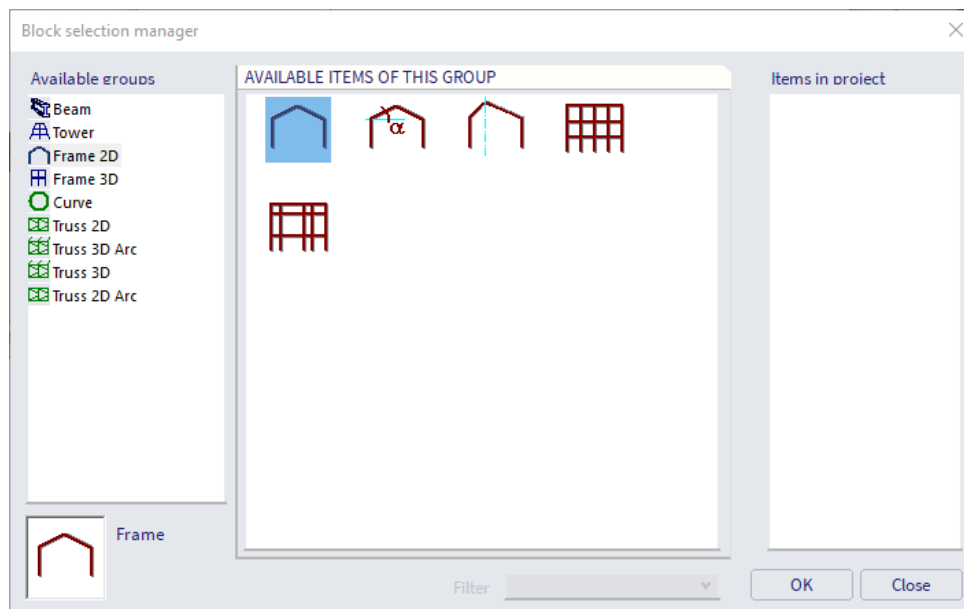

Confirm your choice with **[OK]**.



The **Geometry block** window appears. Now, enter the frame dimensions: **L = 12 m**, **H1 = 5 m** and **H2 = 1 m**. In the combo-box with cross-section selector choose **HE200A** for the **Column** and **IPE180** for the **Beam**.

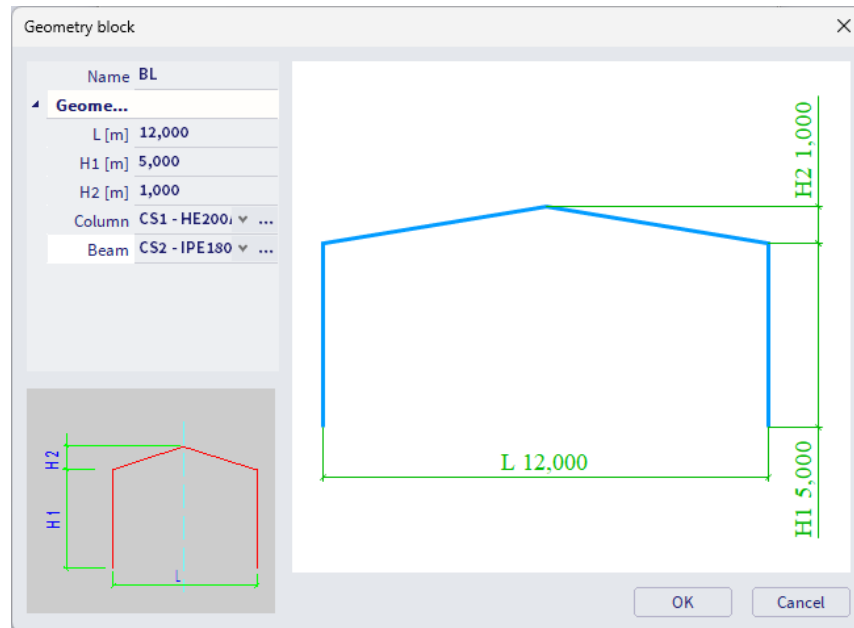

Confirm your input with **[OK]**.

The **Catalogue block manager** appears.

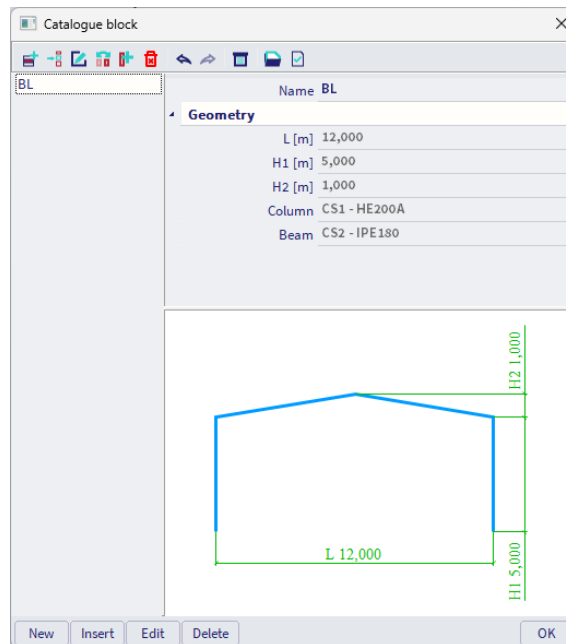

Click **[OK]** to return to the graphical scene. The frame is now graphically represented by thin blue lines attached to mouse cursor. You are now asked to select an insertion point.

The frame is positioned with the left column in the origin of the coordinate system. Type the coordinates **0;0** (with semicolon) or **0 0** (with space) in the SCIA Spotlight and press **<Enter>** to confirm your input.

Block - Insert block - End point >

Finish the input with the **<Esc>** key.

**Notes:**

- The properties of selected elements are shown and can be modified in the **Property panel** on the right-hand side of the user interface.
- With zoom all (**Main menu > View > Zoom > Zoom all**), or double-click with the mouse wheel, you can visualize the entire structure.
- The use of , (comma) or . (point) to work with decimals depends on the regional settings of Windows.
- You can use the @-symbol to work with relative coordinates.

**Multicopy**

After input of the first frame, it can be copied to obtain the other frames easily. As you need two copies, you can use the **Multicopy** function.

First select all (already modelled) entities to be copied. As you must copy all members, you can use the select all (**Main menu > Tools > Selections > Select all**) function.

This way all members and nodes are selected; this is represented by dashed violet lines:

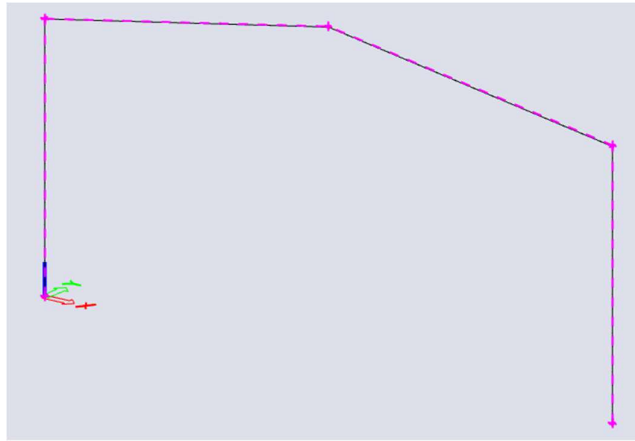

Now, you can select the **Multicopy** command via **Main menu > Edit > Modify > Multicopy** or with the icon in the **workstation Structure**. In the **Number of copies** field enter **2**. To manually set the distance between the frames, deactivate the **Define distance by cursor** option. Now, you can enter the distance 6 m in direction Y.

DISTANCE VECTOR		HOW TO DEFINE THE DISTANCE ?	
Define distance by cursor	<input type="checkbox"/>	<input checked="" type="radio"/> between two copies	
x	0.000 m	<input type="radio"/> from original to the last copy	
y	6.000 m	<b>HOW TO DEFINE THE ROTATION ?</b>	
z	0.000 m	<input checked="" type="radio"/> between two copies	
<b>ROTATION</b>		<input type="radio"/> from original to the last copy	
rx	0.00 deg	<b>ROTATION AROUND</b>	
ry	0.00 deg	<input checked="" type="radio"/> current UCS	
rz	0.00 deg	<input type="radio"/> distance vector	

Number of copies: 2

Insert the very last copy

Connect selected nodes with new beams:

Copy additional data:

Click **[OK]** to confirm your input. New frames are modelled.

Press **<Esc>** to cancel the selection.

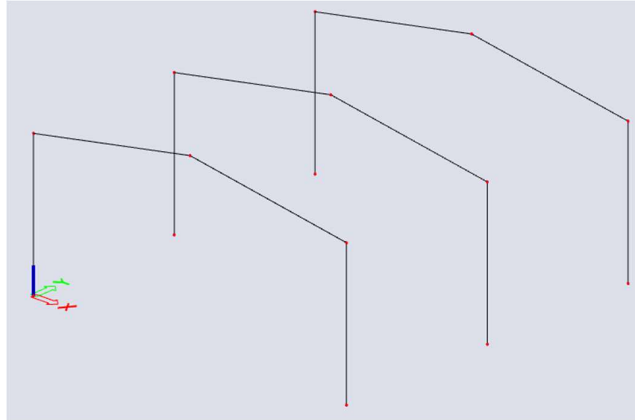

*Note: it's possible to connect the frames automatically with beams with the multicopy command. Therefore use the option **Connect selected nodes with new beams**. After confirming with [OK] the software will ask you for the cross-section for the new beams. When you use this option for your structure, you don't need to select the lower nodes of the columns in this case.*

## Snapping

Connecting beams of the frames can be added after the frames are modelled. The start and end nodes of the beams are already known, i.e. begin and end nodes of the entered members. Therefore you do not have to enter the beams by means of coordinates; instead of that you can use snapping.

You can find **Snapping** in the **Status bar**. You can activate the options **Endpoints / Nodes** and **Midpoints / Centers**.

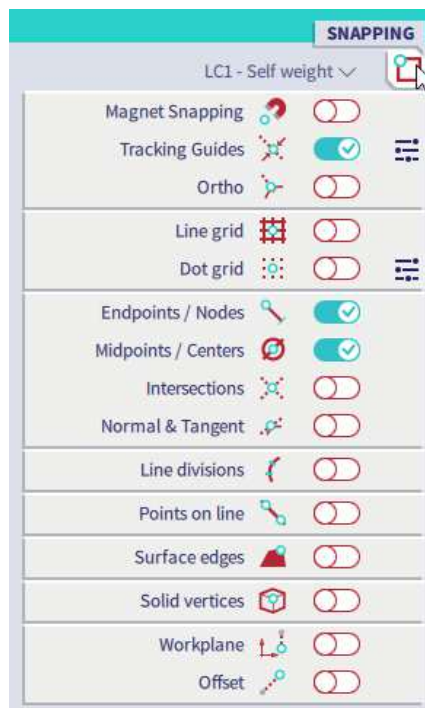

## Entering a beam

To enter a new beam, use the **Beam** command in the **category 1D Members** of the **workstation Structure**.

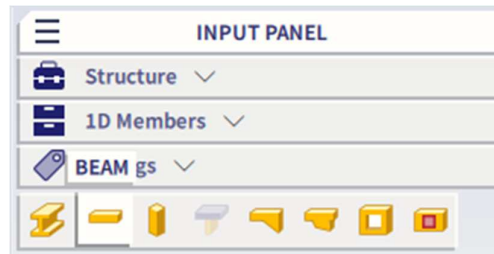

In the **cross-section** field, choose the third cross-section, **CS3 - IPE160**.

For the structure type Frame XYZ or General XYZ there are two horizontal axes (i.e. X and Y), so you must indicate the right direction for the horizontal beam in the **Direct** field. Choose **axis Y**.

The beam **length** is **6 m**.

The **insertion point** is (as default) set to **begin** so that the left point determines the position of the beam.

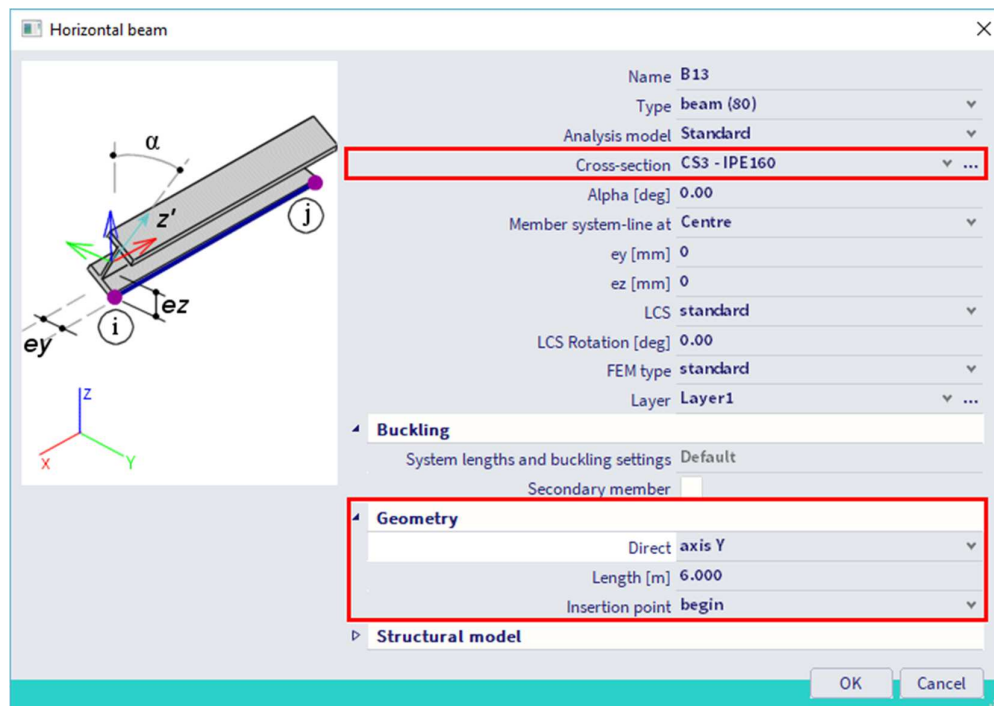

Confirm your input with **[OK]**.

Now, you can enter the beams by clicking with your mouse on the top node of the left-hand side column of the first frame and similar node on the middle frame:

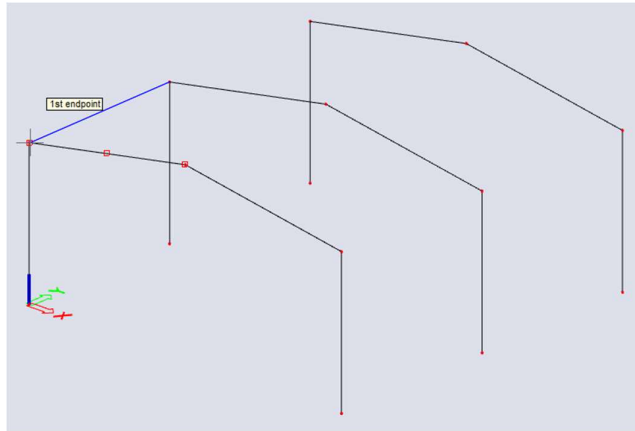

Enter the other beams of the roof in a similar way, always by clicking the top nodes of columns or inclined beams. Add a beam as well at half of the height of the first right span.

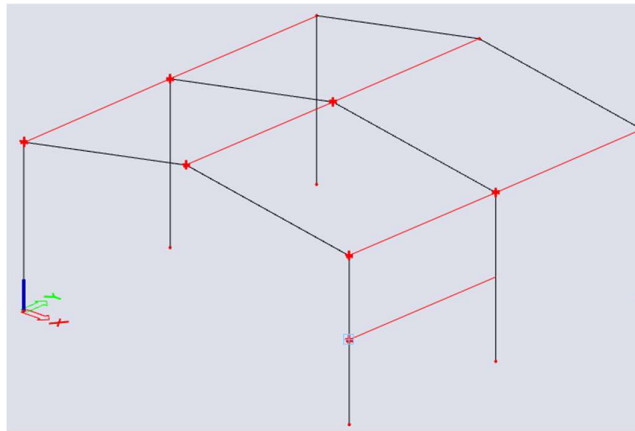

Press **<Esc>** to finish the input.

Press **<Esc>** once more to cancel the selection.

## Entering diagonals

To enter a new diagonal or bracing, use the **1D member** command in the **category 1D Members** of the **workstation Structure** (or via the marking menu).

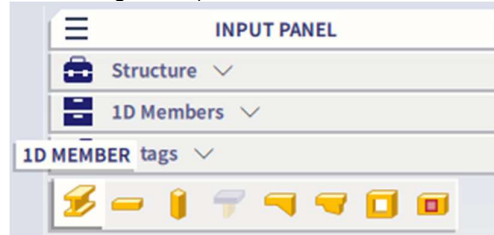

In the **Type** field, choose **Wall Bracing (0)**. This specification is considered for the structural model only and does not influence the analytical model or the results.

In the **Cross-section** field, choose the fourth section, **CS4 - HFLeq 70x70x7**. Note that no length or direction is requested this time, as you will define the geometry afterwards.

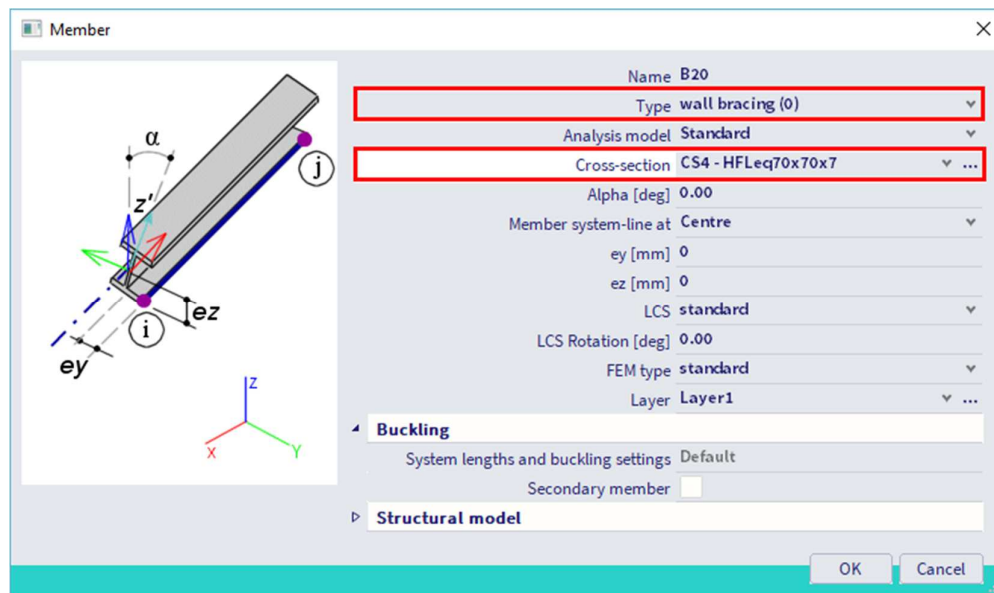

Confirm your input with **[OK]**.

Now, the bracings can be entered between the second and third frame. Click on the start and end nodes of the columns to draw a diagonal.

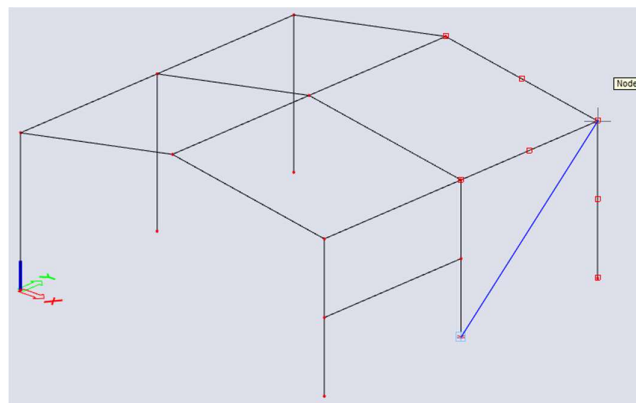

Repeat selecting start nodes and end nodes to model both bracings at the right side.

Press **<Esc>** to finish the input.

Press **<Esc>** once more to finish the selection.

## Copy

We will copy the diagonals from the right side of the structure to the left side of the structure.

First select the entities to be copied. You can select both diagonals with the left mouse button or by dragging a square from right to left with the left mouse button. A violet colour indicates that the diagonals have been selected. Properties of the selected members are shown in the **property panel**.

Click with the right mouse button anywhere in the graphical scene. The appearing context menu lists the available possibilities for the selected entities.

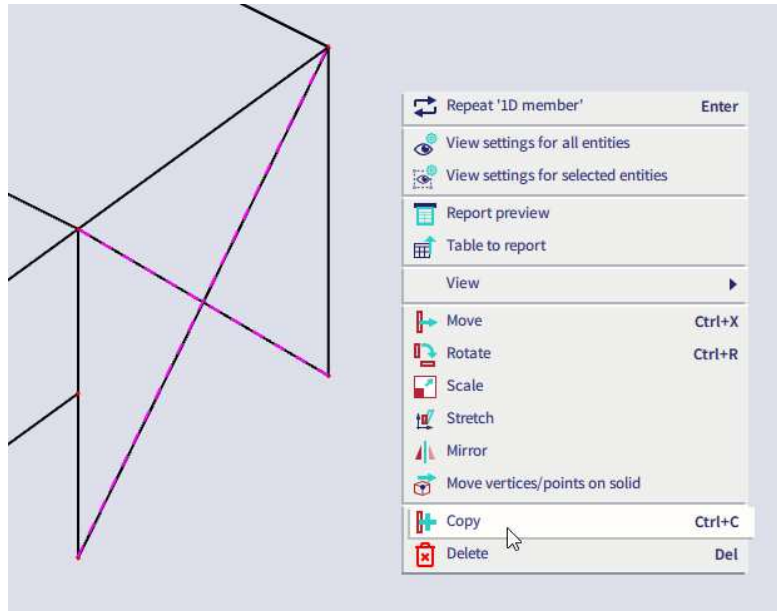

In this menu, choose the option **Copy**.

*Note: instead you can also use **Ctrl+C** as hotkey or you can access the copy command via **Main menu > Edit > Modify** or as icon in the **workstation Structure** of the **process toolbar**.*

Now the program asks the start point of the copy. Click with the left mouse button on the bottom node of the column of the middle frame at the right side. Then you must enter the end point, i.e. the position where the starting point should be copied. Now you can select the bottom node of the column of the middle frame at the left side.

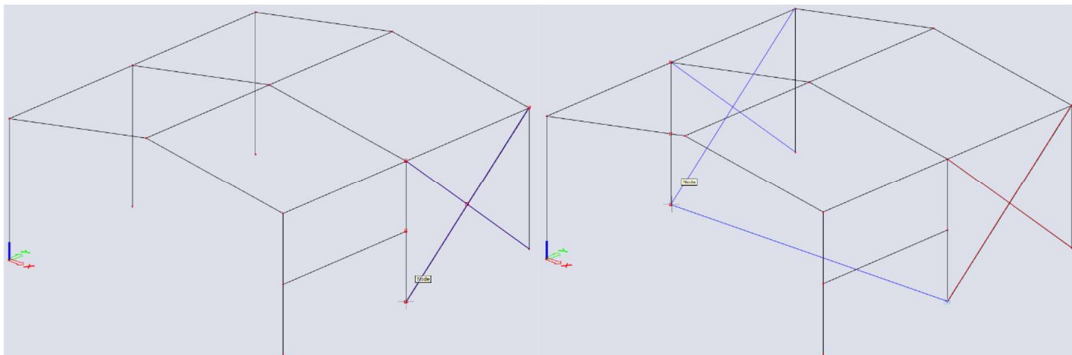

When the members are copied, the command remains active until you press **<Esc>**, so that you can copy as well to other positions if needed.

Press **<Esc>** to finish the input.

Press **<Esc>** once more to cancel the selection.

### 3.1.3. Additional data

The structure is completely set up. Now, you can finish the geometry input by adding end conditions, i.e. enter haunches, hinges and supports.

#### Haunches

In SCIA Engineer every member is regarded as prismatic, with a constant cross-section, until a haunch is entered. Haunches are entered on the roof beams in this project, at the column sides. A haunch is defined by the following parameters:

- a cross-section with variable height;
- a length, over which the variable height must vary up to 0.

To enter a new haunch, use **Haunch on 1D** command in the **category 1D Members** of the **workstation Structure**.

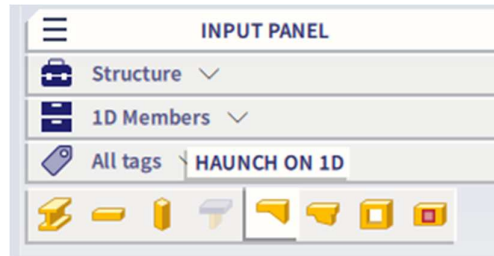

As indicated, a haunch requires a cross-section with a possibility to create variable dimension(s). Since this project does not contain any variable profiles yet, the **New cross-section** window automatically appears.

Select in **Available groups** the **Haunch** group.

In **Available items of this group**, choose a **I + I var** cross-section.

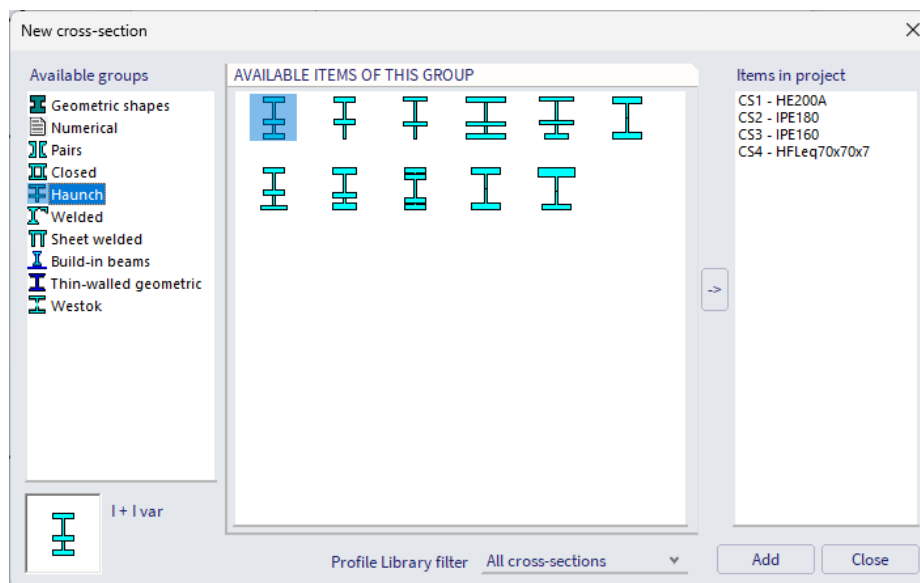

Click **[Add]** or on the arrow-button to add the cross-section to the project.



Now the cross-section window appears. Here, the properties of the variable cross-section can be changed.

In the **I section** field, change the section in an **IPE180** by clicking the button behind the section type.

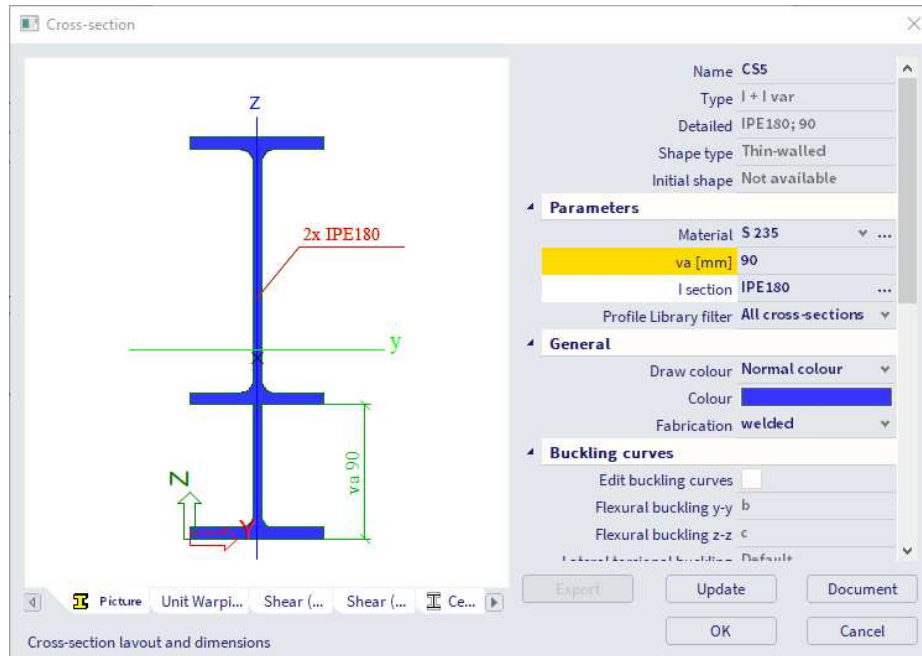

Confirm your input with **[OK]** and use button **[Close]** to close the **New cross-section** dialogue.

The cross-section manager appears; click **[OK]** to close this window as well.

Now, the **Haunch on beam** window is opened.

In the **Position** field, choose **Begin** to position the haunch at the start node of the member.

In the **Coord. definition** field, choose the option **Abso** to indicate that the length, over which the variable height must vary, can be entered in absolute units, i.e. in meter.

When the coordinate definition is adapted, the length of the haunch can be entered in the **Length x [m]** field. For this project, enter length **1 m**.

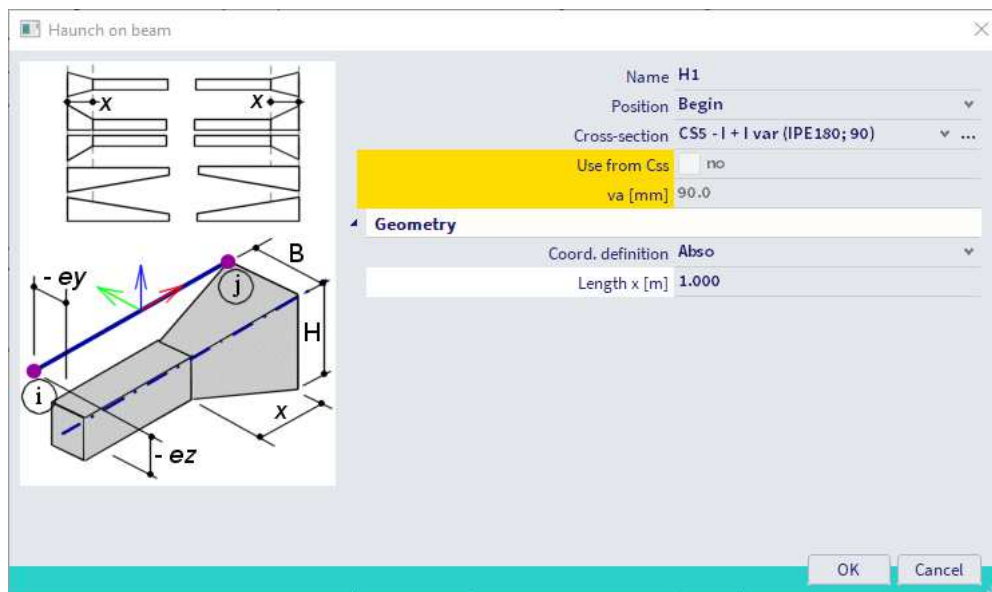

Confirm your input with **[OK]**.

Now, the program asks to indicate the members on which a haunch must be entered. Select the 6 roof beams with the left mouse button:

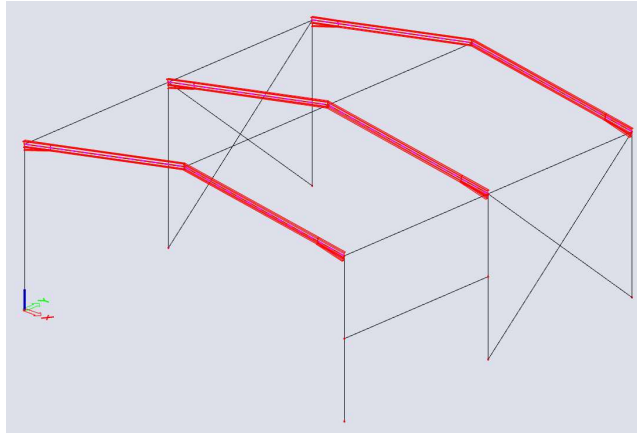

Press **<Esc>** to finish the input.

Press **<Esc>** once more to cancel the selection.

To visualize the haunches, you need to click the following buttons in the **view bar**:

- **Volumes** to show the surfaces of the sections;
- **Shading** to obtain a rendered view of the members.

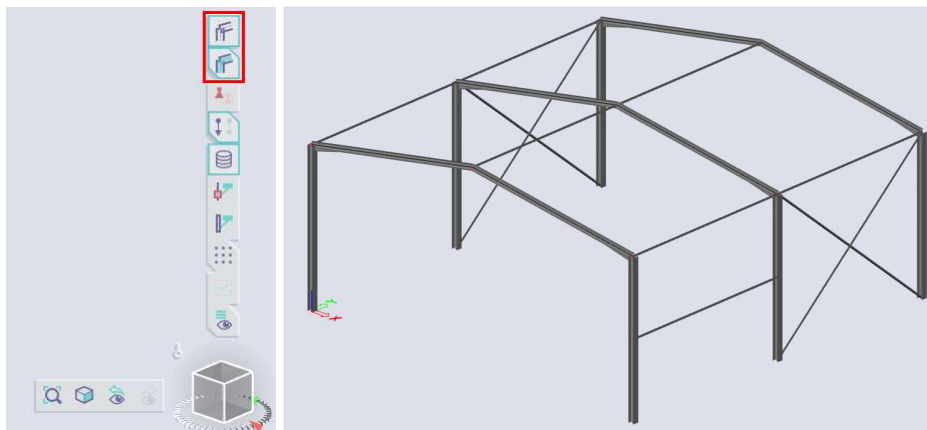

***Note:** a haunch overwrites specification of the original cross-section. For this project, this specifically means that the cross-section of the roof beam is replaced by the I + I var cross-section. If the haunch is removed, the I + I var cross-section will be maintained instead of the I-section of the roof beam.*

## Hinges

In SCIA Engineer, every node where two or more members connect is regarded as fixed, until a hinge is entered and some translations and/or rotations are released.

In this project, the diagonals should be connected with the other members in a hinged way. Therefore, you must enter hinges manually.

To enter hinges, use the **Hinge on 1D** command in the **category 1D Members** of the **workstation Structure** (or via the marking menu).



The hinges are put to both ends of the diagonals; therefore choose **Both** for the **Position** when dialogue **Hinge on beam** pops-up.

To obtain a hinge, the rotations **fiy** and **fiz** are set to **Free**, the **translations** and the rotation **fix** remain **Rigid**.

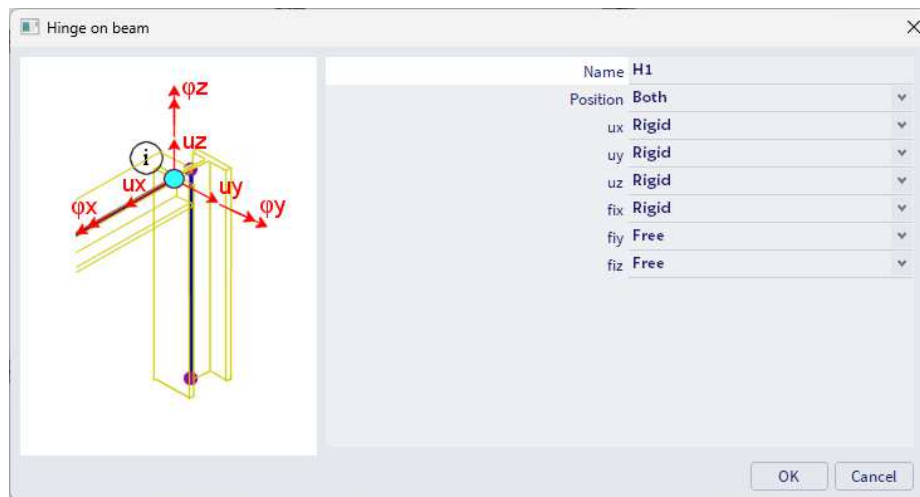

Confirm your input with **[OK]**.

The hinges are added when you click the diagonals with the left mouse button.

Press **<Esc>** to finish the input.

Press **<Esc>** once more to finish the selection.

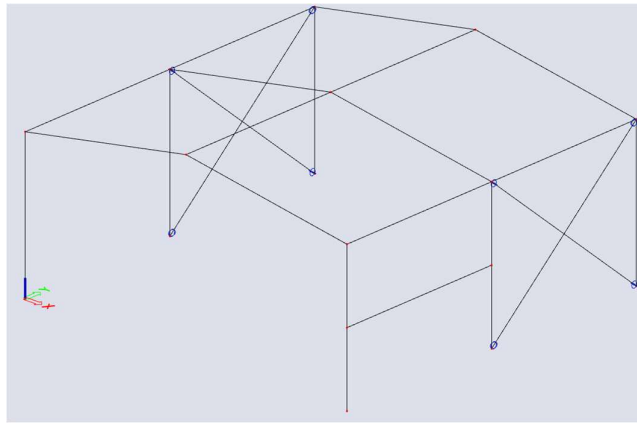

Notes:

- Instead of adding hinges to the diagonals, you can set the property **FEM type** to **axial force only** in the **property panel**. Pay attention to not combine hinges with this property, since this could lead to issues for the solver when calculating the model.
- Hinges are always defined with regard to the local coordinate system of a member.
- Increase **Scale add data** in the **Status bar** if you feel that the hinge symbol is too small.



## Supports

The geometry input can be completed with supports. The column bases are modelled with hinges.

Before adding the supports, you first can select the nodes to position the supports. You can select these nodes manually, one by one, but SCIA Engineer offers a simple method to select multiple entities based on a common property.

To select all column bases, select one of the bottom nodes, by drawing a frame from the left to the right with the mouse cursor.

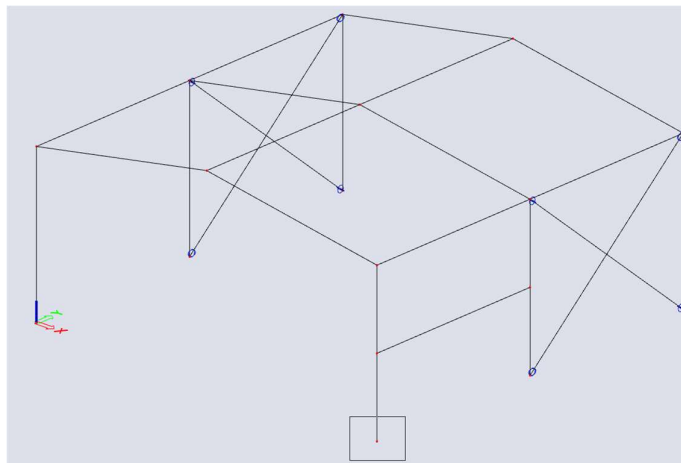

The **property panel** shows the properties of this node. Now, choose the property to be used for the selection of the entities. For this project, you want to select all bottom nodes. The common property of these nodes is their coordinate in global Z direction.

Click with the right mouse button on the **Z [m]** property to select the appropriate row and choose the **Expand selection** option.

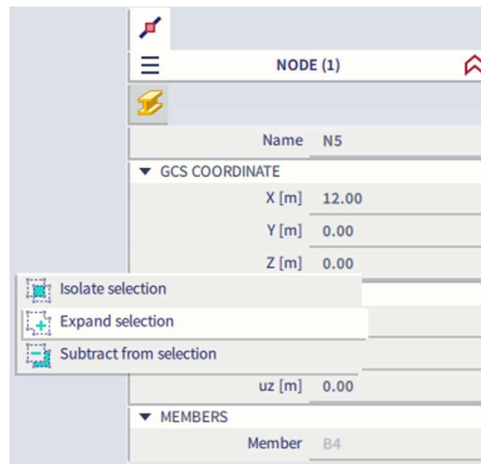

The program will search all entities with the same property. In this example, the program will select all nodes, for which the Z [m] property corresponds to 0 m.

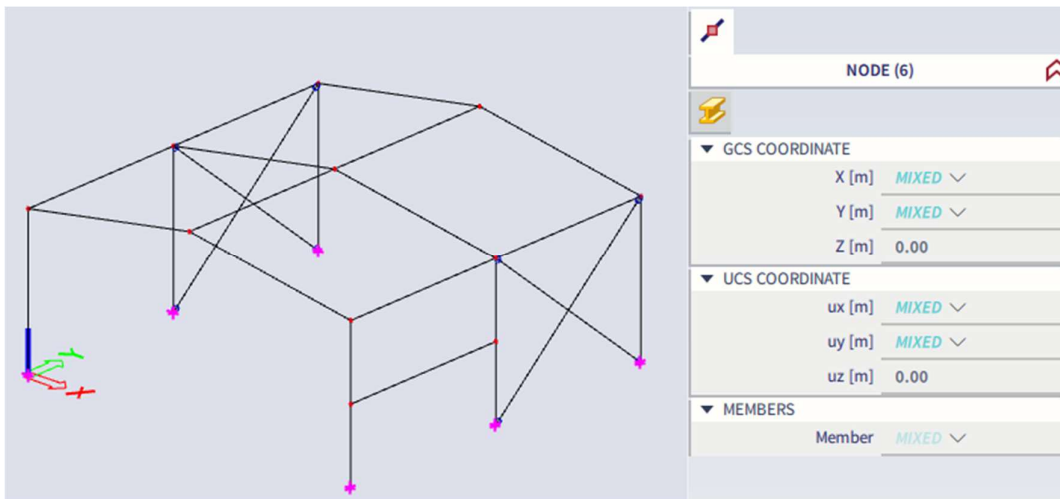

The column bases are selected. Now, supports can be added to these nodes.

To enter supports, use the **Support in node** command in the **category 1D Members** of the **workstation Structure** (or via the marking menu).

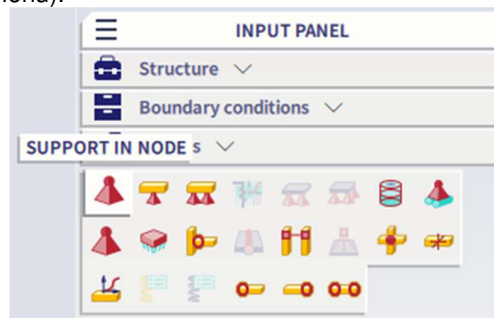

You can easily define all 6 end conditions at once by choosing the **Constraint as Hinged**, so that all **translations are Rigid** and all **rotations are Free**.

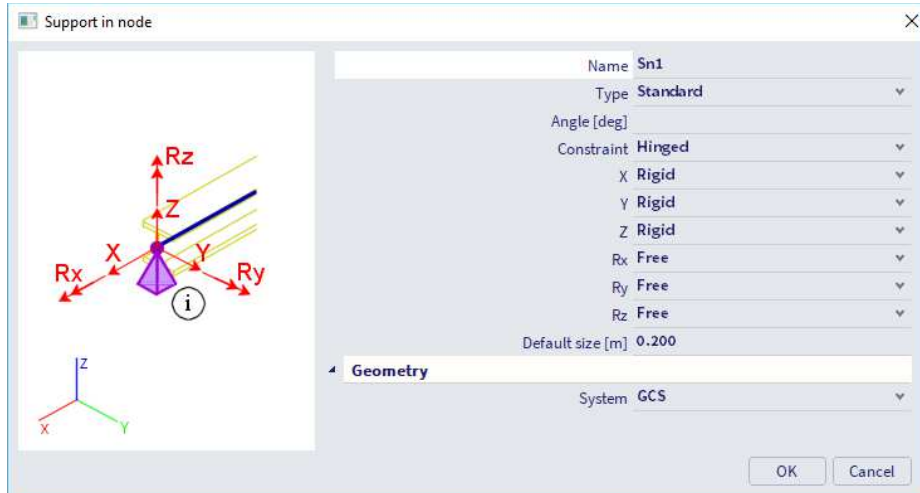

Confirm your input with **[OK]**. The supports are automatically attributed to the selected nodes.

Press **<Esc>** to finish the selection.

Notes:

- If you draw the selection box from the left-hand side to the right-hand side with the mouse cursor, only entities which are completely inside will be selected. If you draw the rectangle from the right-hand side to the left-hand side, the entities which are completely in the rectangle as well as the entities that intersect with the rectangle will be selected.
- The **input panel** includes a number of predefined supports via the tag **Quick input**. For this project, you could have used the **Hinged support in node** icon.



- Similar to the selection of supports, you could have used the **Expand selection** option to select all diagonals, when the hinges had to be entered. The determinant property here would have been the cross-section.

### 3.1.4. Check structure

After input of the geometry, the input can be checked for errors by means of the option **Check structure**. With this tool, the geometry is checked for duplicate nodes, zero beams, duplicate members, wrong references of hinges or supports etc. However, this tool does not check if the structure is correctly supported or if it is a mechanism.

You can find the command **Check structure** as icon in the **workstation Structure** of the **process toolbar** or via **Main menu > Tools > Check structure**.

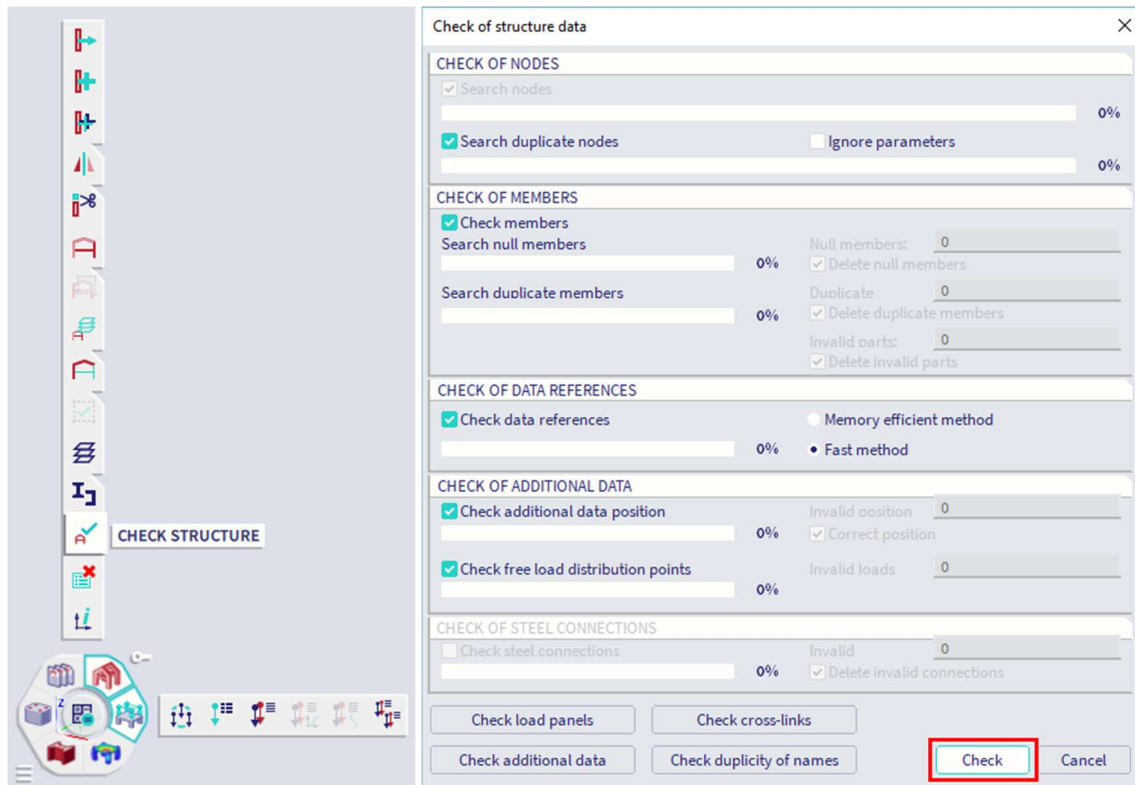

In the **Check of structure data** dialogue the different available checks are listed. Click [**Check**] to perform the checks.

The **Data check report** window appears, indicating that no problems were found.

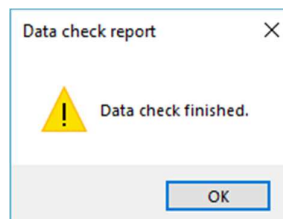

Close the check by clicking [**OK**].

In case of any problem SCIA Engineer tries to automatically correct the structure data (delete duplicated entities, correct wrong reference, etc.).

### 3.1.5. Graphic representation of the structure

Within SCIA Engineer there are several possibilities to edit the graphic representation of the construction. Below you will find the most important options:

- edit the view point of the model;
- use Zoom commands;
- edit view parameters.

You can set the view point with the **Navicube**.



You can rotate/tumble, pan, zoom, set the view in the direction of one of the global axes,... All possibilities are shown on following help-page: [https://help.scia.net/20.0/en/#rb/basictools/adjusting\\_the\\_view.htm](https://help.scia.net/20.0/en/#rb/basictools/adjusting_the_view.htm)

#### Notes:

- *If the structure is being turned while a node is selected, the structure will turn around the selected node.*
- *You can also easily zoom in and zoom out with the mouse wheel. The mouse wheel can be used to move the model in case you press it and hold. Double-click of the wheel zooms the structure so that it can be seen completely (the whole graphical scene is filled by the structure).*

Several zoom commands are available via **Main menu > View > Zoom**

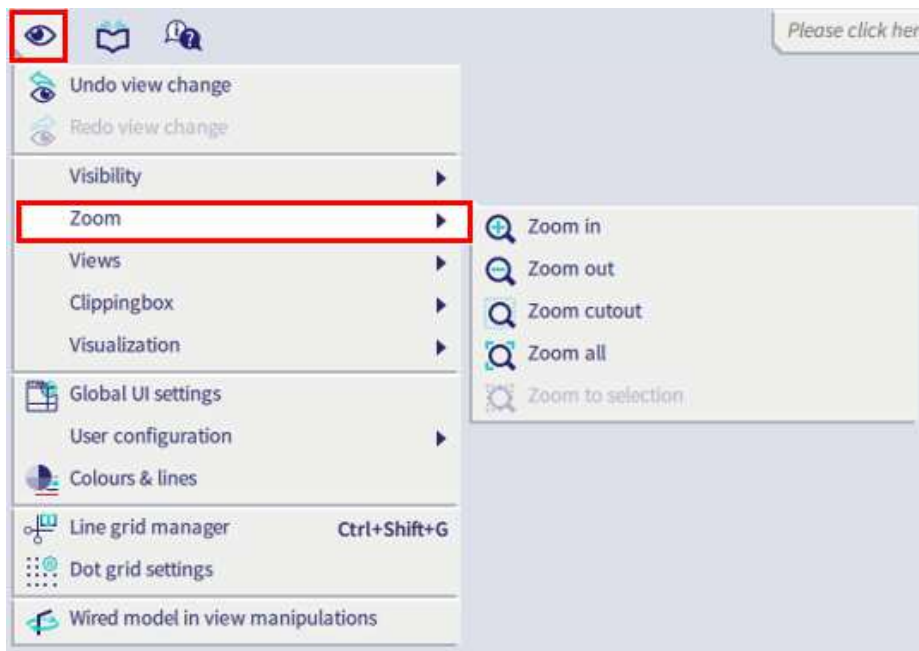

Note: **Zoom to selection** is only available in case that you have made a selection in the model.



You can use the **view bar** to **show/hide volumes, shading, supports, loads, model data, labels of nodes, labels of members,...**

Via **More options** you can choose for **More view settings** in order to access all view parameters. You can access this dialogue as well via right-clicking in the graphical scene and choosing for **View settings for all entities** or **View settings for selected entities** (if an entity or multiple entities are selected you can change view settings for only that selection).

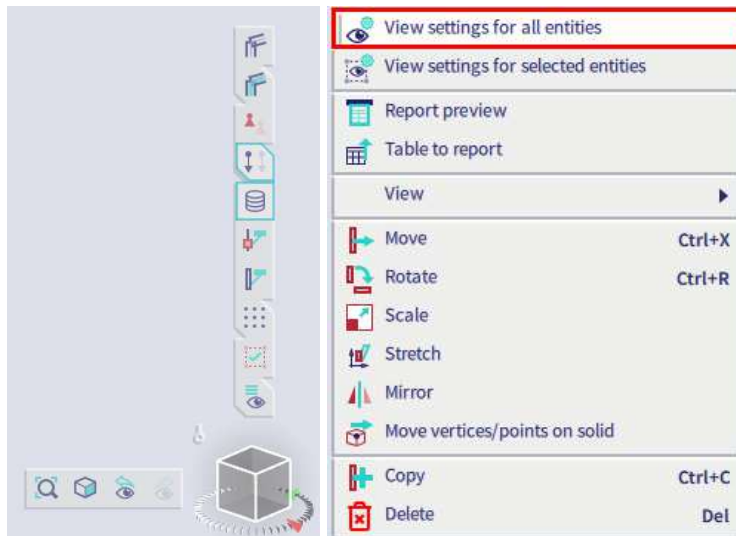

Through the tab **Structure** the representation of the different entities can be adapted

- **Style and colour:** you can display the colour per layer, material, cross-section, structural type or design group.
- **Draw cross-section:** with this option checked the symbol of the cross-section is displayed on every 1D member.
- **Local axes:** with this option the local axes of the elements are activated.

Through the tab **Labels**, the labels of different entities can be displayed. In the group **Beam labels** the following items can be displayed in the label:

- **Name:** show the name of the member in the label (e.g. B1)
- **Cross-section name:** show the name of the cross-section in the label (e.g. CS1)
- **Cross-section type:** show the cross-section type in the label (e.g. HEA200).
- **Length:** show the length of the member in the label (e.g. 5.000 m).

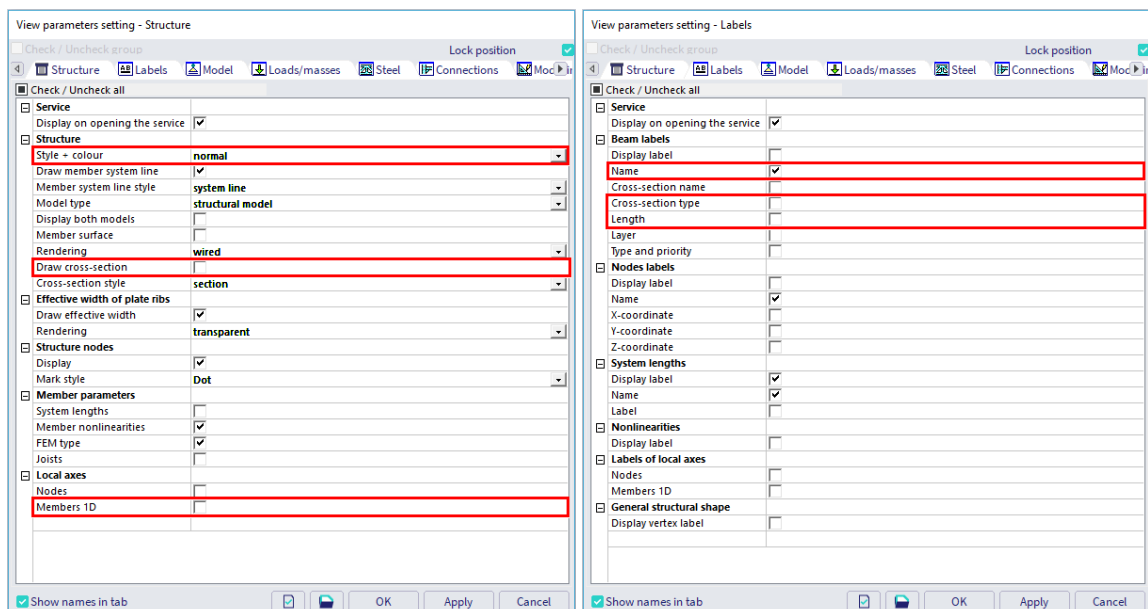

## Chapter 4: Loads and combinations

### 4.1. Load cases and load groups

Each load is attributed to a **load case**. One load case can contain different load types like line loads, surface loads, ... To each load case, properties are attributed which are determinant for the generation of combinations. The action type of a load case can be permanent or variable.

Each load case is associated with a **load group**. The load group contains information about the category of the load (service load, wind, snow...) and its appearance (default, together, exclusive). In an exclusive load group, the different load cases attributed to this load group cannot act together in a single combination when using envelope combinations or code combinations.

We recommend that you thoroughly read the chapter about loads and combinations in the reference manual or on our help pages.

Three load cases are entered in this project:

- LC1: Permanent load case **Self weight**;
- LC2: permanent load case **Other permanent loads**;
- LC2: variable load case: **Wind** (side wind on the frames).

You can find the command **Load cases** as icon in the **workstation Loads** of the **process toolbar**, via the hotkey **Ctrl+L** or via **Main menu > Libraries > Load cases, combinations > Load cases**.



Before you can define loads, you must enter load cases first. Since this project does not contain any load cases yet, the **Load Cases** manager will automatically appear and by default, the load case LC1 is automatically created. This load is a permanent load of the **Self weight** load type. The self weight of the structure is automatically calculated, although not graphically displayed.

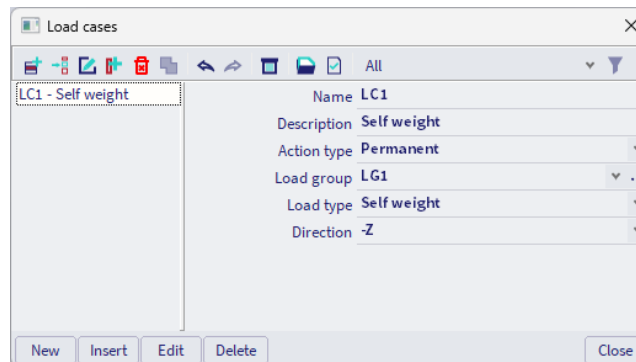

We will create a second permanent load case for the roof weight. Click on **[New]** and change the **Description** to **Other permanent loads**. The **Load type** is now set to **Standard**.

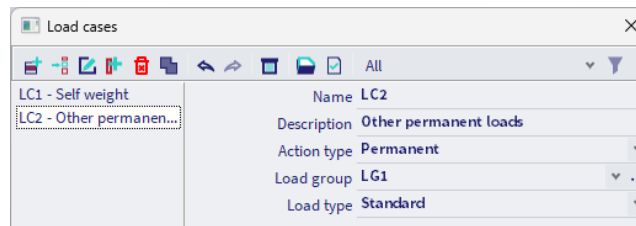

Now we will create a variable load case. Click on [**New**], change the **Description** to **Wind** and change the **Action type** to **Variable**.

The load group LG2 is automatically created. Click on the three dots [...] to display properties of the load group.

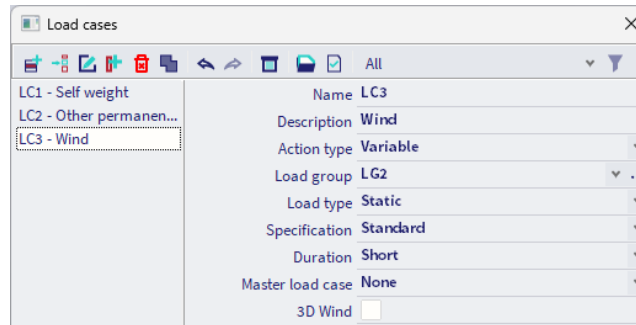

The **Load type** determines the composition factors (psi-factors) that are attributed to the load cases in this load group. In this project choose **Wind**.

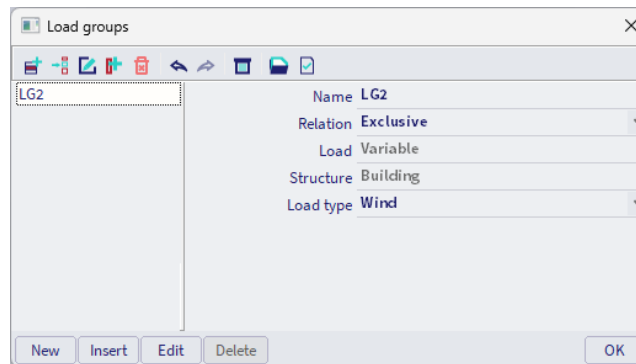

Click [**OK**] to close the load group manager and to return to the load cases manager.

Click [**Close**] to close the load cases manager.

*Note: each load is classified in a load group. These groups influence the combinations that are generated as well as the code-dependant coefficients to be applied. The following logic is adopted. Variable load cases that are independent from each other are associated to different variable groups.*

*For each group, you set the load category (see EN 1991). The combination factors from the Eurocode are generated from the available load groups. When a generated combination contains two load cases belonging to different groups, reduction factors will be applied for the transient loads.*

*If the load is divisible, its different components are entered as individual load cases. As long as the load combination does not contain any variable load belonging to another group, no reduction factors may be applied. The different load cases of a divisible load are therefore associated to one variable group. Load cases of the same type that may not act together, are put into one group, which is made exclusive, e.g. "Wind X" and "Wind -X" are associated to one exclusive load group "Wind" to avoid simultaneous action.*

## 4.2. Load panels

We will make use of load panels to distribute surface loads to line loads on the members.

To enter load panels, use the **Panel with load to 1D & edges** command in the **category Load panels** of the **workstation Structure** (or via the marking menu).

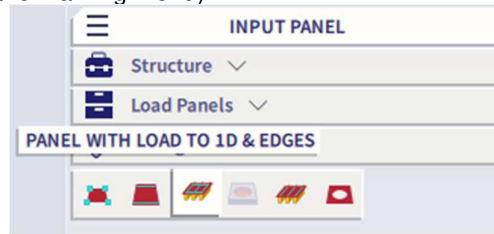

Set **Load transfer direction** to **X (LCS panel)** and **Load transfer method** to **Tributary area** in the properties dialogue.

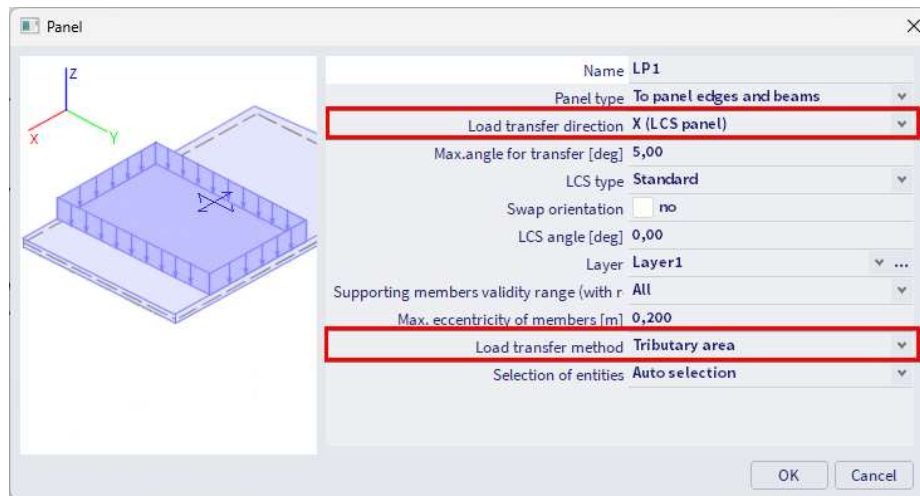

Use the snapping points in the roof to create a load panel for each pitch of the roof.

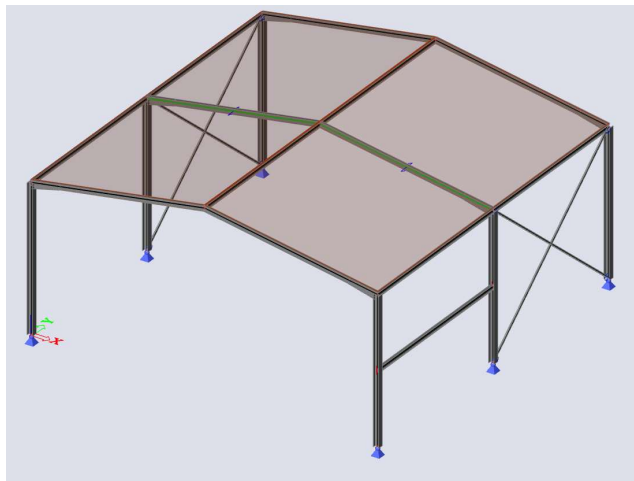

Press **<Esc>** to finish the input.

Press **<Esc>** once more to deselect the load panels.

*Note: the first two nodes that you use to create the geometry of the load panel will determine the load transfer direction. You can change the direction if needed via the property panel.*

### 4.3. Loads

In the **status bar** you can change the active load case. Activate load case LC2.

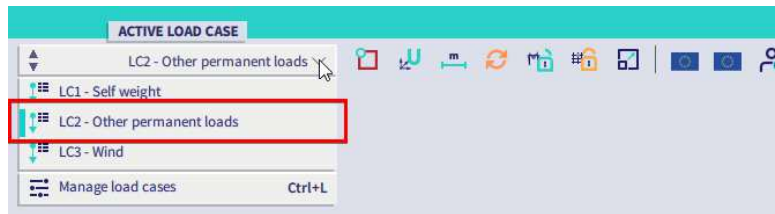

Select the **Surface load on 2D** command in the **category Surface loads** of the **workstation Loads** (or via the marking menu).



Set **Value [kN/m<sup>2</sup>]** to **-0.20** in the properties dialogue. The **Direction** is the global **Z** direction and the value is negative, so the load is acting vertically downwards.

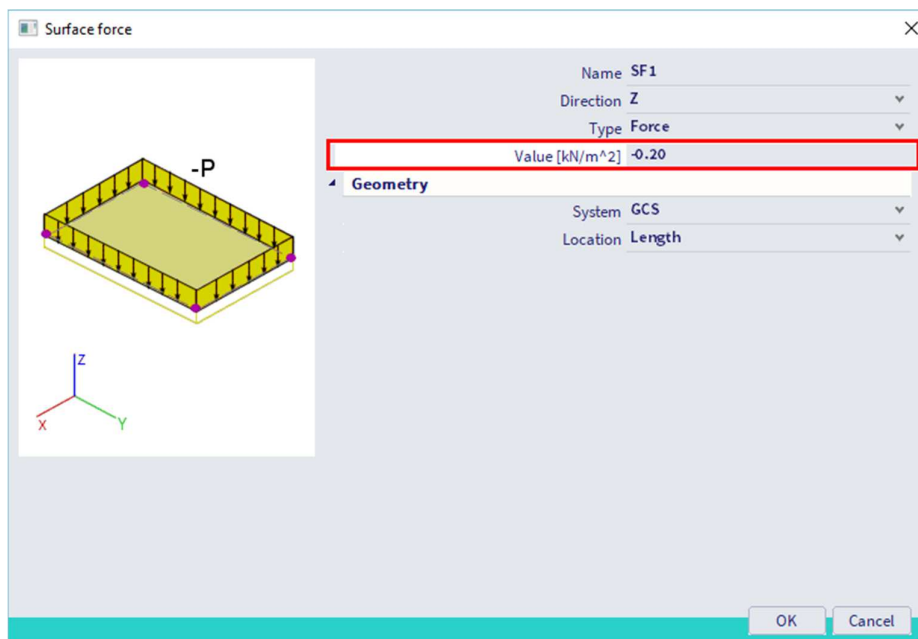

Confirm your action with **[OK]**.

Select all load panels by clicking on them or use the select all command (**Main menu > Tools > Selections > Select all**).

Press **<Esc>** to finish the input.

Press **<Esc>** once more to finish the selection.

The loads are coloured in green.

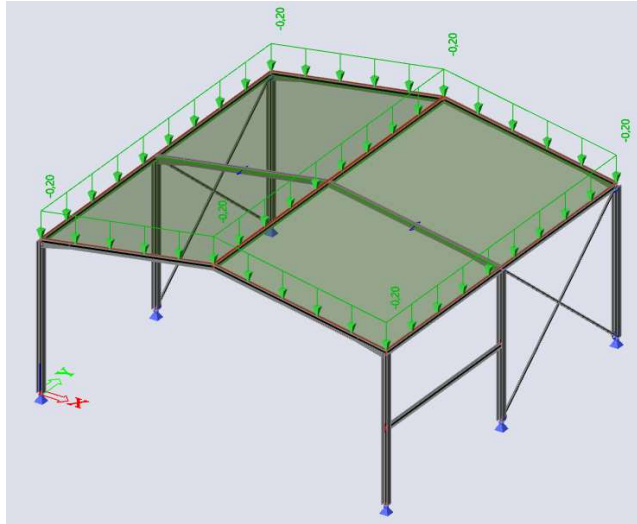

When you calculate the model, the loads will automatically be converted from surface loads to line loads.

If you like you can already generated them before the analysis to evaluate them. Therefore select a load panel and in the **property panel** choose **Generate loads** as **Action**. The generated loads are coloured in orange.

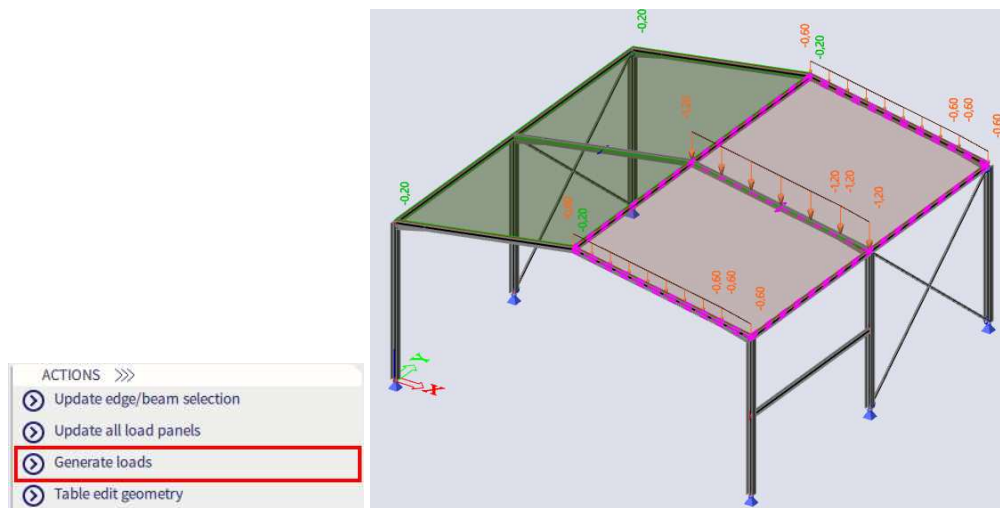

Go to the **view settings** and switch on the tab **Loads/masses** the **Generators** to **Generated** or **Original + Generated** if the loads remain green. Or use the toggle in the View bar.

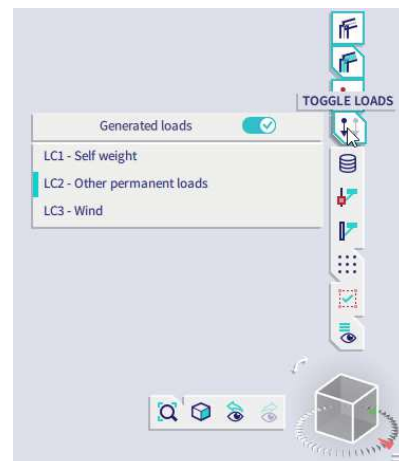
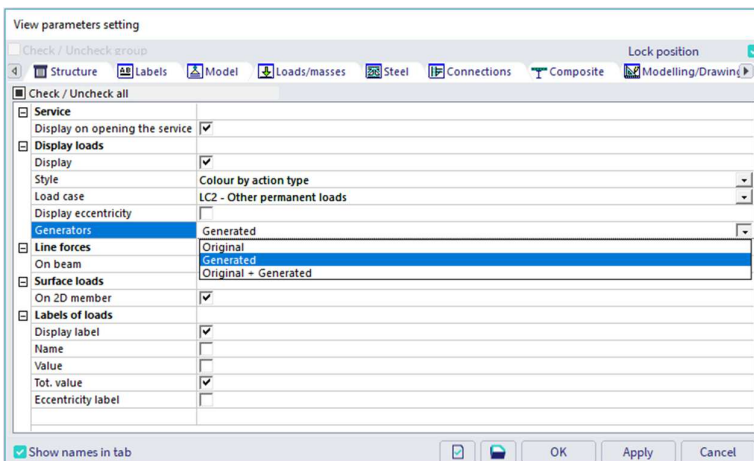

In the **status bar** change the active load case to load case LC3.

Select the **Line load on 1D** command in the **category Line loads** of the **workstation Loads** (or via the marking menu).



Set **Value - P [kN/m]** to **-2.80** in the properties dialogue. The load **Direction** is **Z** and the **System** is the local coordinate system **LCS**. The linear loads are acting in accordance with the local Z-axes of the elements.

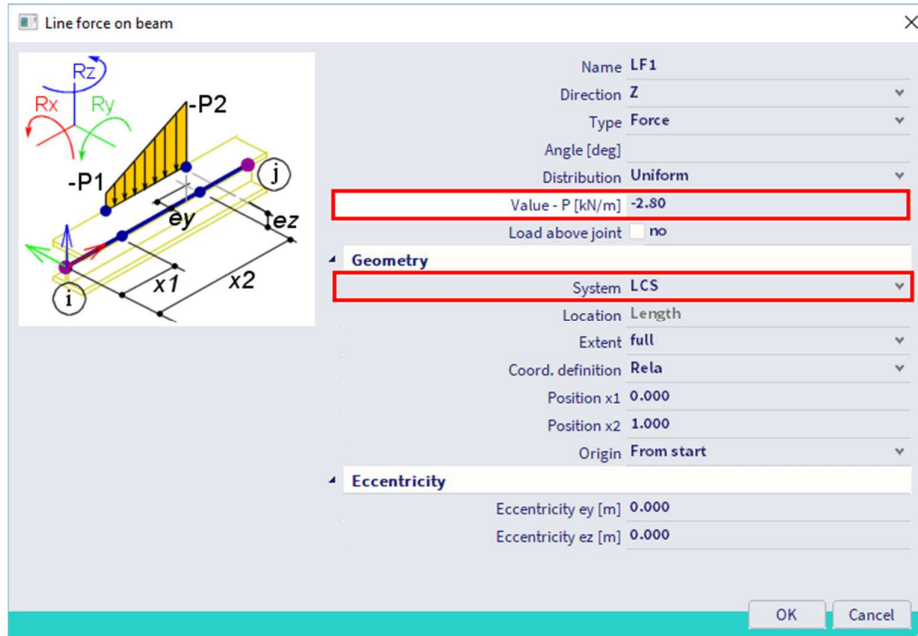

Confirm your input with **[OK]**.

Select the members where this load must be positioned: the roof girders and the columns.

Press **<Esc>** to finish the input.

Press **<Esc>** once more to finish the selection.

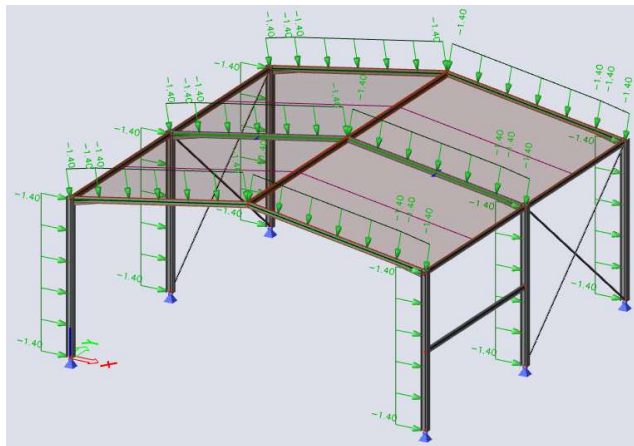



Select the linear loads on the roof girders and the columns of the first and last frame by clicking with the left mouse button on these loads. The mentioned members must have only half of the load value because only half of the loading width, affected by wind, belongs to them.

The common properties of the 8 series are displayed in the property panel. Change the value from **-2.80 kN** to **-1.40 kN**.

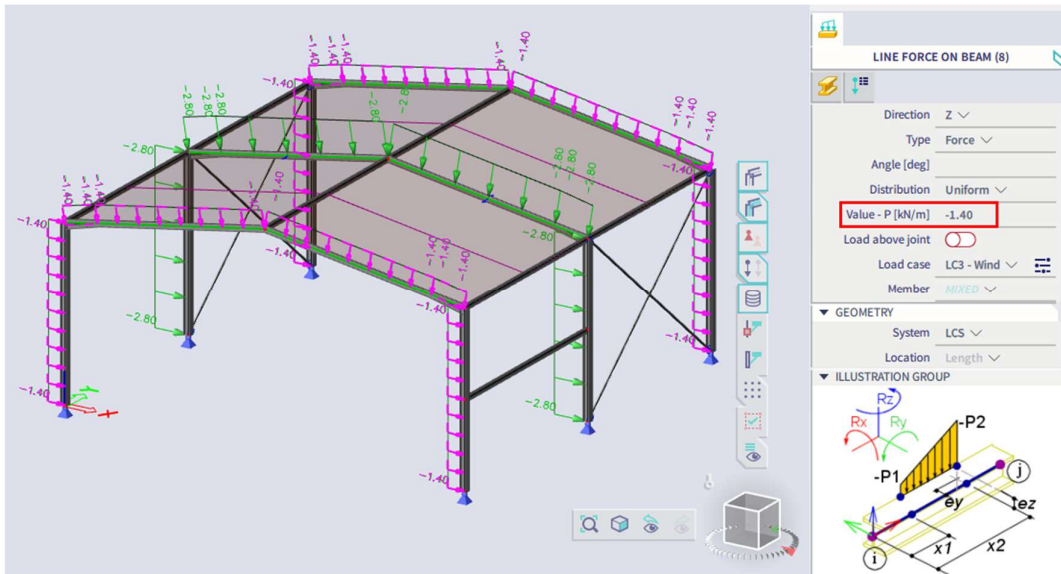

Note that you can also use simple formulas in these numerical input fields:





## 4.4. Combinations

By default automatic code combinations are activated in the **Actions** tab of the **Project data** dialogue (via **Main menu > File > Project Settings**).

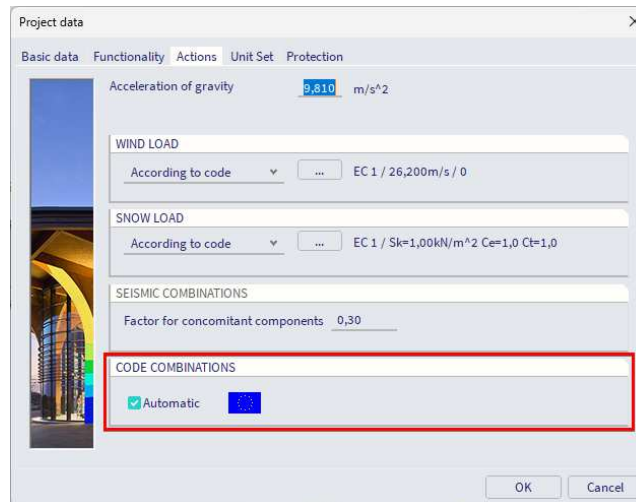

Click on the command **Combinations** in the **workstation Loads** in the **process toolbar** (or via **Main menu > Libraries > Load Cases, combinations > Combinations**) to have a look at the automatic generated combinations.



Two code combinations are created, one for the Ultimate Limit State and one for the Ultimate Serviceability State.

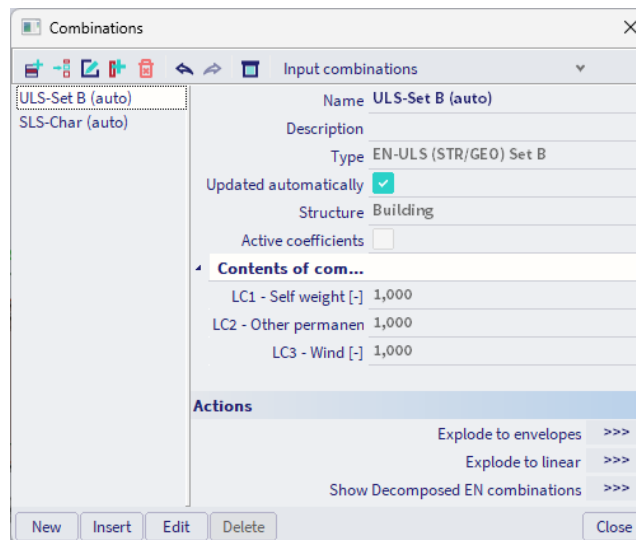

You can click on [**>>>**] next to the Action **Explode to linear** to have a look at the individual linear combinations to evaluate if the load groups are defined correctly.

## Chapter 5: Analysis

### 5.1. Linear analysis

As the calculation model is completely ready, you now can start the calculation.

Use the **Calculate** button in the middle of the process wheel in the **process toolbar** to start the analysis (or via **Main menu > Tools > Calculation & Mesh > Calculate**).



Make sure that the option **Connect members/nodes** is turned on in the **Mesh setup**, so all entities are properly connected before the analysis. Select **Linear analysis** and press **Calculate**.

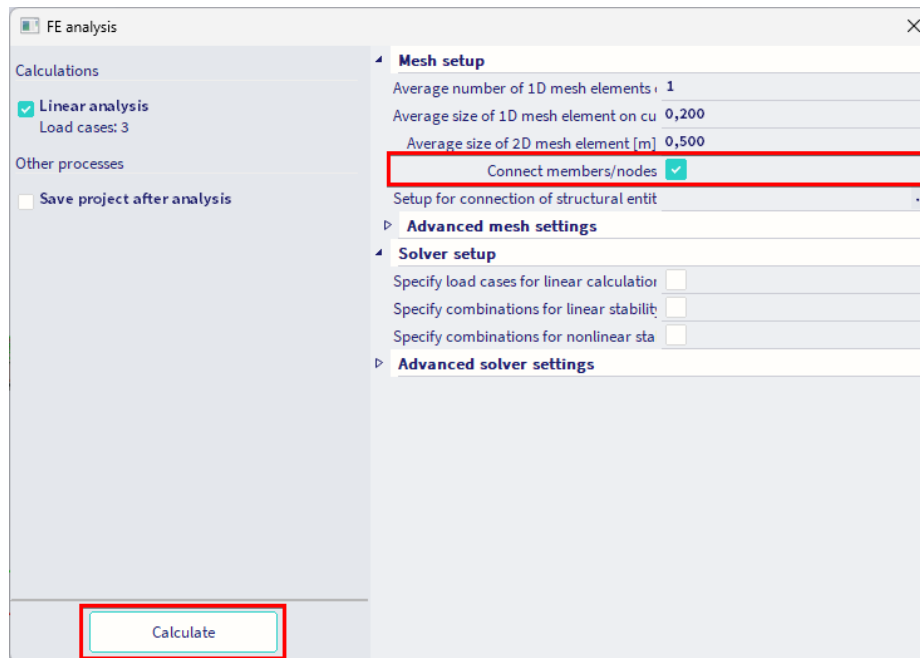

The calculation process dialogue indicates the progress of the analysis. After finishing the analysis, you can consult the Results tab and view the maximum deformation and rotation for the normative load case. Click **[Close]** to close this window.

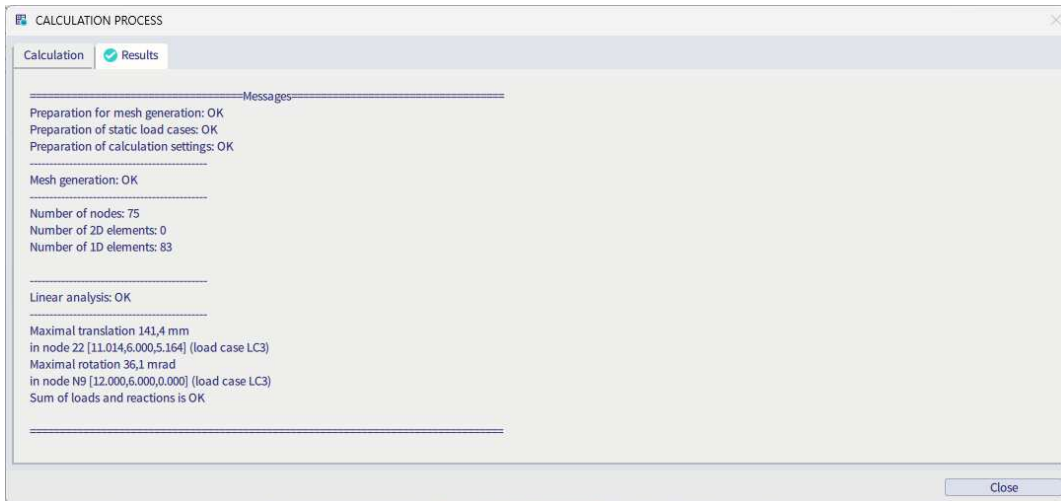
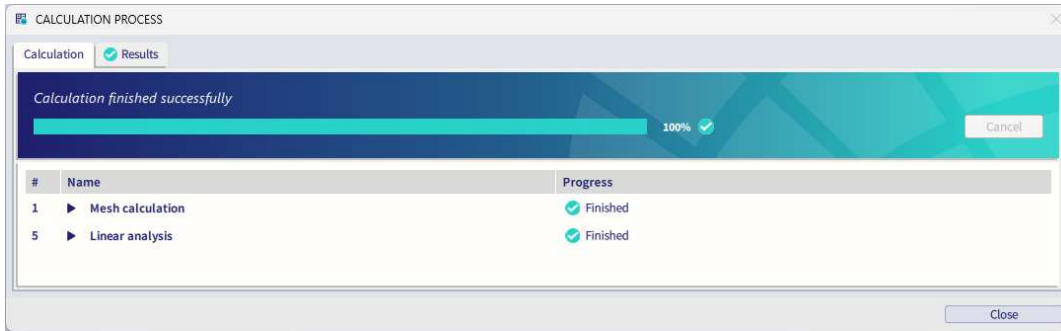

## Chapter 6: Results

When the calculation is completed, results can be viewed. The relevant commands in the **workstation Results** become active now.

### 6.1. Reactions

Select the **workstation Results** in the **process toolbar** and click on the command **Reactions**.



Go to the **property panel** and set:

- **Type of selection** to **All**
- **Type of load** to **Combinations**
- **Combination** to **ULS-Set B (auto)**
- **Extreme** to **Mesh**
- **Values** to **R\_z**

The action button **Refresh** has an orange highlight, i.e. the graphical scene must be refreshed. Press the action button **Refresh** to display the results in the graphical scene in accordance with the options above.

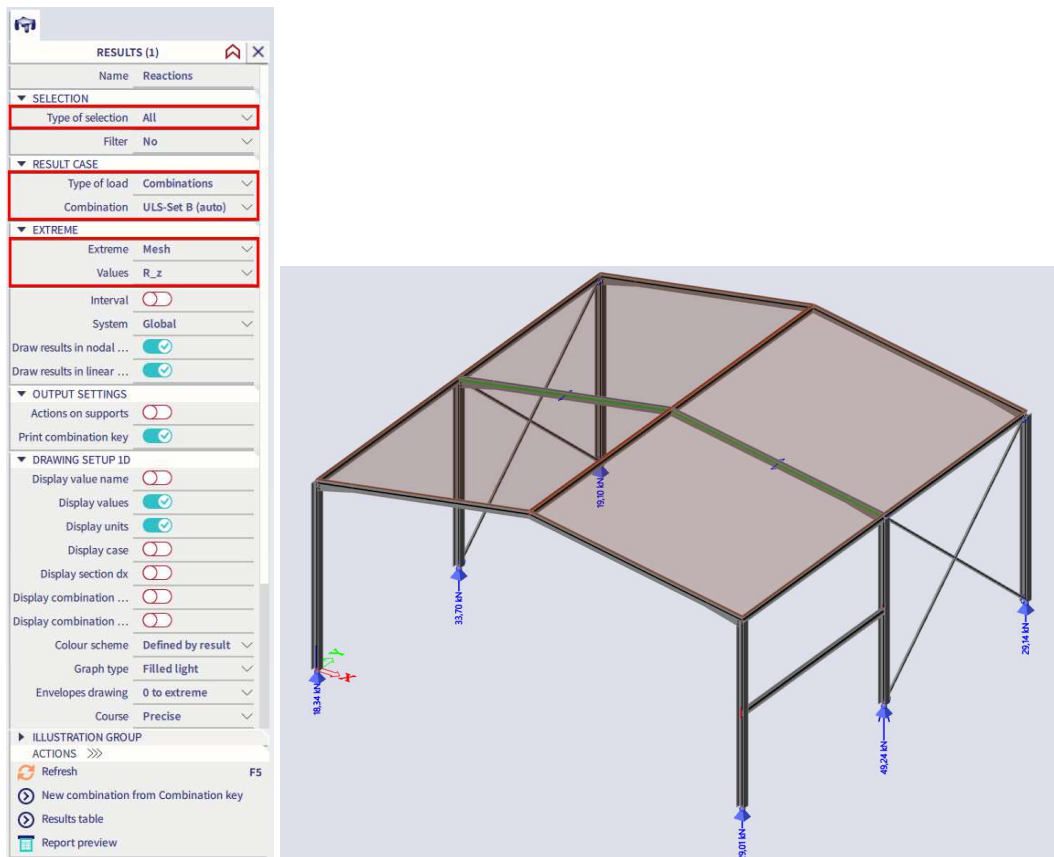

To display these results in a table, the **Preview** action is used. Click on **Report preview**.

REPORT PREVIEW

Reactions

Linear calculation  
Combination: ULS-Set B (auto)  
System: Global  
Extreme: Mesh  
Selection: All

**Nodal reactions**

Name	Case	R <sub>x</sub> [kN]	R <sub>y</sub> [kN]	R <sub>z</sub> [kN]	M <sub>x</sub> [kNm]	M <sub>y</sub> [kNm]	M <sub>z</sub> [kNm]	e <sub>x</sub> [mm]	e <sub>y</sub> [mm]
Sn1/N1	ULS-Set B (auto)/1	<b>2,57</b>	0,07	10,34	<b>0,00</b>	<b>0,00</b>	<b>0,00</b>	0,0	0,0
Sn1/N1	ULS-Set B (auto)/2	1,90	<b>0,05</b>	<b>7,66</b>	0,00	0,00	0,00	0,0	0,0
Sn1/N1	ULS-Set B (auto)/3	-3,93	<b>0,10</b>	<b>18,34</b>	0,00	0,00	0,00	0,0	0,0
Sn1/N1	ULS-Set B (auto)/4	<b>-4,59</b>	0,08	15,66	0,00	0,00	<b>0,00</b>	0,0	0,0
Sn2/N5	ULS-Set B (auto)/4	-17,78	<b>0,10</b>	26,16	0,00	0,00	0,00	0,0	0,0
Sn2/N5	ULS-Set B (auto)/1	-2,57	<b>0,13</b>	10,98	<b>0,00</b>	<b>0,00</b>	<b>0,00</b>	0,0	0,0
Sn2/N5	ULS-Set B (auto)/2	<b>-1,90</b>	0,10	<b>8,13</b>	0,00	0,00	0,00	0,0	0,0
Sn2/N5	ULS-Set B (auto)/3	<b>-18,45</b>	0,13	<b>29,01</b>	0,00	0,00	<b>0,00</b>	0,0	0,0
Sn3/N9	ULS-Set B (auto)/2	<b>-3,19</b>	<b>0,40</b>	<b>12,88</b>	<b>0,00</b>	<b>0,00</b>	<b>0,00</b>	0,0	0,0
Sn3/N9	ULS-Set B (auto)/3	<b>-32,42</b>	<b>1,68</b>	<b>49,24</b>	0,00	0,00	<b>0,00</b>	0,0	0,0
Sn4/N10	ULS-Set B (auto)/1	<b>4,31</b>	0,58	16,80	<b>0,00</b>	<b>0,00</b>	<b>0,00</b>	0,0	0,0
Sn4/N10	ULS-Set B (auto)/2	3,19	<b>0,43</b>	<b>12,44</b>	0,00	0,00	0,00	0,0	0,0
Sn4/N10	ULS-Set B (auto)/3	-6,83	<b>1,20</b>	<b>33,70</b>	0,00	0,00	0,00	0,0	0,0
Sn4/N10	ULS-Set B (auto)/4	<b>-7,95</b>	1,05	29,34	0,00	0,00	<b>0,00</b>	0,0	0,0
Sn5/N14	ULS-Set B (auto)/2	<b>-1,90</b>	<b>-0,50</b>	<b>8,23</b>	<b>0,00</b>	<b>0,00</b>	<b>0,00</b>	0,0	0,0
Sn5/N14	ULS-Set B (auto)/3	<b>-18,45</b>	<b>-1,81</b>	<b>29,14</b>	0,00	0,00	<b>0,00</b>	0,0	0,0
Sn6/N15	ULS-Set B (auto)/1	<b>2,57</b>	-0,66	11,10	<b>0,00</b>	<b>0,00</b>	<b>0,00</b>	0,0	0,0
Sn6/N15	ULS-Set B (auto)/3	-3,93	<b>-1,30</b>	<b>19,10</b>	0,00	0,00	0,00	0,0	0,0
Sn6/N15	ULS-Set B	1,90	<b>-0,49</b>	<b>8,22</b>	0,00	0,00	0,00	0,0	0,0

## 6.2. Internal forces

Select the **workstation Results** in the **process toolbar** and click on the command **1D internal forces**.



Go to the **property panel** and set:

- **Type of selection** to **Current**
- **Type of load** to **Combinations**
- **Combination** to **ULS-Set B (auto)**
- **Extreme 1D** to **Member**
- **Values** to **M<sub>y</sub>**

Select columns and the roof girders of the middle frame using the left mouse button.

Click on the **Refresh** button to display the results on the graphical screen in accordance with the defined options.

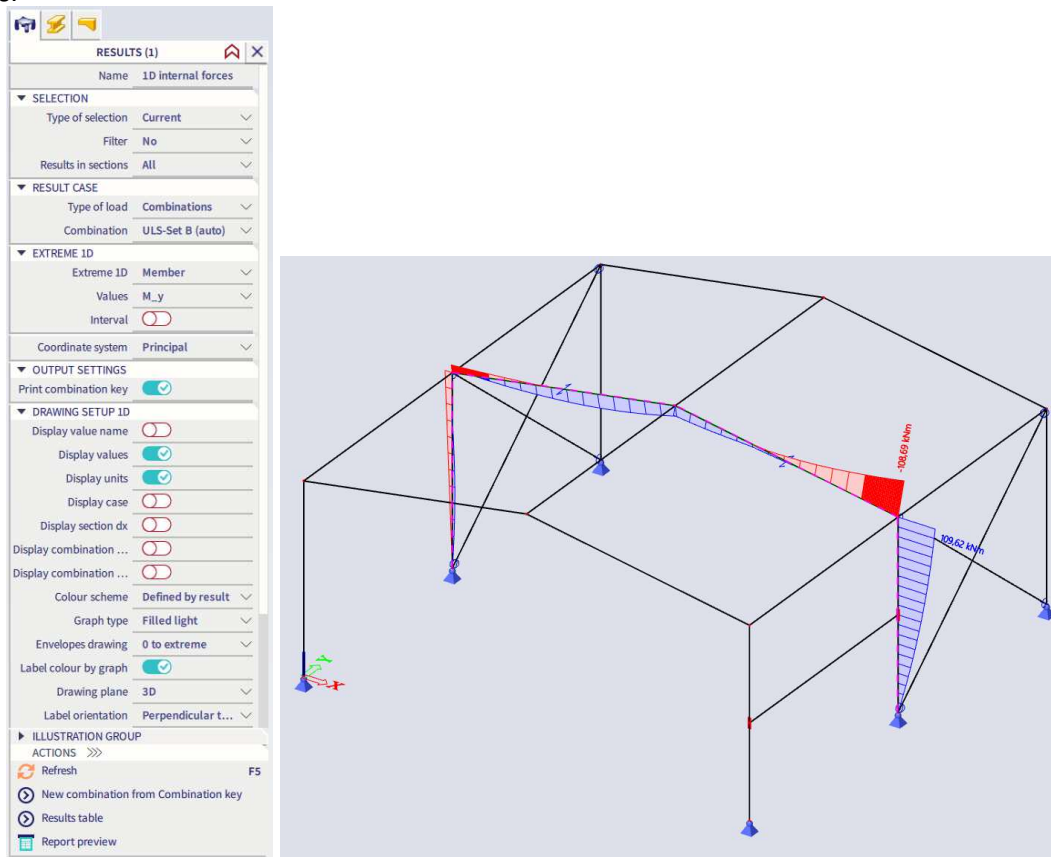

To change the display of the results, the settings of the graphical scene can be adapted via the options in the group **Drawing setup 1D** in the property panel. You can display units, change the colour scheme or graph type, ...

*Note:* to change the font size of the displayed results, you can use **Main menu > View > Colours & lines**. In this menu, the different sizes of the displayed labels can be changed. Units can be changed via the **status bar > Unit system > Manage units**.

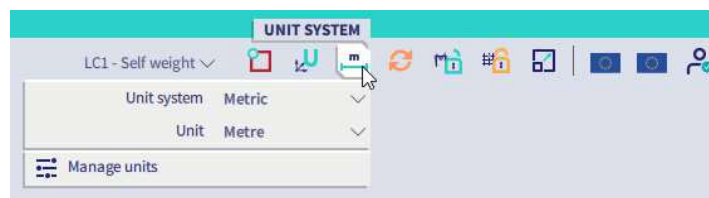

## 6.3. 3D deformations

Select the **workstation Results** in the **process toolbar** and click on the command **3D deformations**.

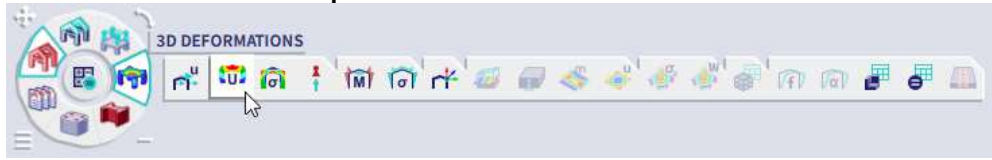

In the **property panel** you can set similar settings as we saw before, like **Type of selection**, **Type of load**, **Extreme 1D**, **Extreme 2D**, ...

For the **Values** you can choose between the displacements and rotations for the local axis or for the total deformation **U<sub>total</sub>**.

There is an option **Wireframe**. When it's turned on, only centre lines and centre planes are used for calculation and displaying the results. This option is much less demanding on performance resulting to faster visualization of the results and the deformed shape of the structure.

With the option **Deformed structure** the result values can be displayed on deformed surface of the structure.

 The image shows the 'RESULTS (1)' property panel on the left and a 3D visualization of a deformed structure on the right. The panel is configured as follows:
 

- Name: 3D displacement
- SELECTION: Type of selection: All; Filter: No
- RESULT CASE: Type of load: Combinations; Combination: SLS-Char (auto); Envelope (for 2D drawl...): Absolute extreme
- Wireframe:  (unchecked)
- Location: In nodes avg. on ...
- Value: U<sub>total</sub>
- System: LCS mesh element
- Extreme 1D: Global
- Extreme 2D: Global
- CALCULATE RESULTS ON ...: 1D members: ; 2D positive face: ; 2D negative face:
- DEFORMED STRUCTURE: Deformed structure: ; Member deformation: for global maxim...
- For drawing use linear ...:  (unchecked)
- ERRORS, WARNINGS AND NOTES SETTINGS: Show information abo...: ; Show errors: All; Show warnings: All; Show notes: In extremes only
- Show table with expla...:
- ILLUSTRATION GROUP ACTIONS: Refresh (F5), New combination from Combination key, Drawing setup 3D, Results table, Report preview

 The 3D visualization on the right shows a complex truss-like structure with a color gradient representing displacement values. The structure is shown in a perspective view, highlighting its deformed state under load.

## 6.4. Results-related status bar options

In the **status bar** you can find two results-related icons.

- You can switch from **Manual refresh** (the icon is coloured in **orange**) to **Autorefresh** (the icon is coloured in **blue**) and then the results will automatically be refreshed when a result setting in the **property panel** is changed. Pay attention with the Autorefresh setting for bigger models when the property Type of selection is set to All, because it will take longer to refresh the results (especially when you would ask for 3D results without the wireframe option turned on).



- When you activate the icon **Results lock**, results can still be requested when making changes to the model. This is clearly indicated with an exclamation mark and a red square around the graphical scene. Of course later on recalculating the model is still needed to obtain new internal forces, deformations, ...





## Chapter 7: Code checks

The steel modules include a number of tools to perform steel calculations in accordance with the chosen design code. The possibilities are as following:

- input of steel data per member;
- input and manipulation of buckling data;
- input of stiffeners, lateral-torsional buckling restraints, steel sheeting, ...;
- performing a ULS unity check;
- optimization of the cross-section;
- performing a SLS unity check;
- performing a fire-resistance check;
- input, calculation and creation of drawings for connections;

We will only explain the basics of the steel design in this tutorial. For more information regarding advanced steel calculations (like 2<sup>nd</sup> order analysis, fire-resistance checks, ...) we refer to the Advanced Steel Training.

### 7.1. Buckling parameters

Before the steel code checks can be executed, the buckling parameters of the members need to be checked. By means of the view settings, the buckling lengths of the members can be visualized. Select member B1 and activate the option **System lengths** under **Member parameters** in the tab **Structure** of the **View settings**.

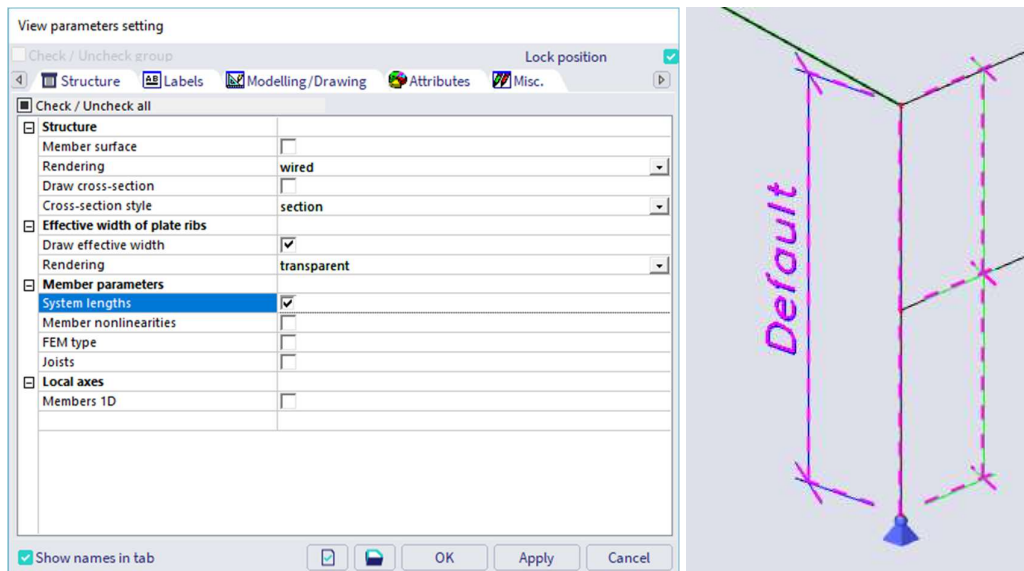

The figure above shows that the (default) system/reference length  $L_y$  (blue line) for buckling around the strong axis (y-y) is the total height of the column and  $L_z$  (green line) for buckling around the weak axis (z-z) is half of the height. The girder in the middle of the column therefore supports the column for buckling around the weak axis.

To modify the buckling data of a member, select the element and click on the button **Manage** next to the option **System lengths and buckling settings** in the **property panel**.

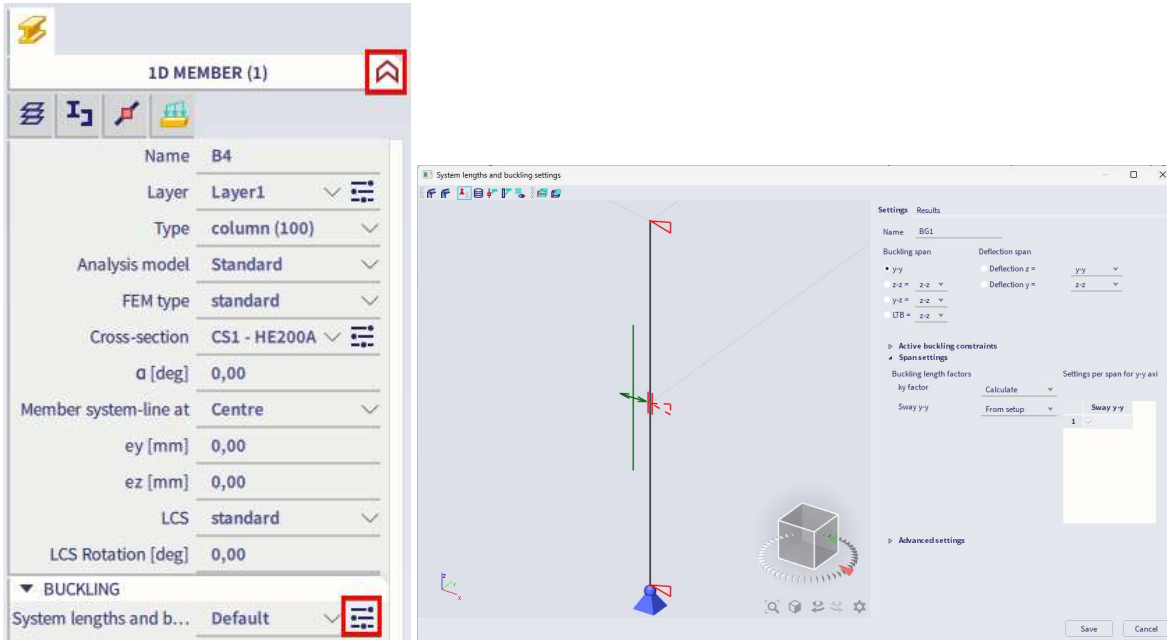

On the **Settings** tab, several data can be changed:

- The **Name** field contains the name of the buckling parameter, in this case BG1.
- For buckling around y-y and z-z you can set the **ky** and **kz factor**: you can indicate that the program should calculate the buckling factor automatically or you can choose a manual input of this factor. A third option allows for a manual input of the buckling length (instead of factor).
- You can set as well **Sway y-y** and **Sway z-z**: you can indicate if the member is “braced” or not in the direction regarded. When you choose option **From setup**, the default settings are used.  
*Note: the default settings for the buckling parameters are listed in **Steel settings** in the **workstation Steel**. The structure is by default sway for buckling around the strong axis (in the plane) and non-sway for buckling around the weak axis out of plane), taking the presence of wind bracings outside of the plane into account.*
- You can define as well settings for torsional buckling (y-z), lateral torsional buckling (LTB) and both deflection directions (used for the SLS check). By default settings are taken from y-y or z-z, but this can be changed with the drop-down lists.

Select the command **Steel slenderness** in **workstation Steel** of the **process toolbar**.



Go to the **property panel** and set **Selection** to **Current** and **Values** to **Ly**.

Then press **Refresh** to see the result for the reference length around the strong axis.

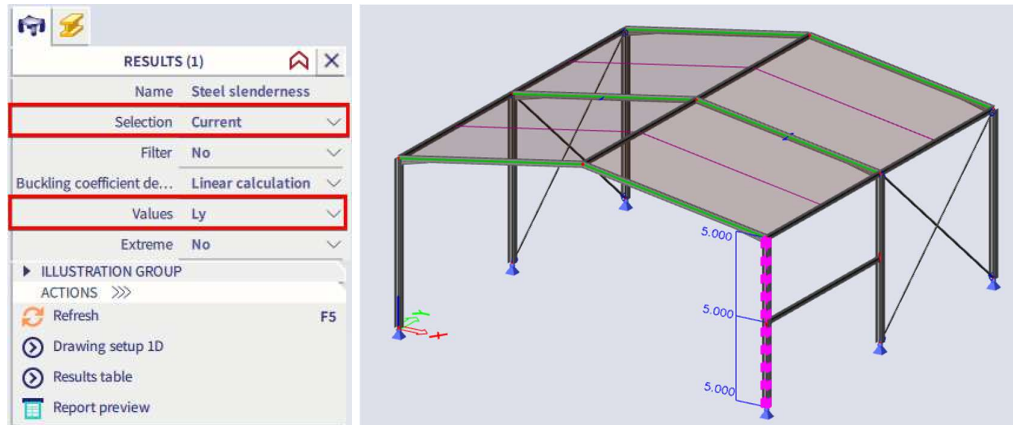

You can ask as well for the slenderness ( $\lambda_y$  or  $\lambda_z$ ), buckling factor ( $k_y$  or  $k_z$ ), buckling length ( $l_y$  or  $l_z$ ),... The buckling length is determined as the reference length multiplied by the buckling factor.

## 7.2. Steel code check

### 7.2.1. ULS check

The ULS (Ultimate Limit State) unity check includes both a section and a stability check.

Select the command **Steel ULS check** in **workstation Steel** of the **process toolbar**.



Go to the property panel and set:

- **Type of selection** to **All**
- **Filter** to **Cross-section**
- **Cross-section** to **CS1 - HE200A**
- **Type of load** to **Combinations**
- **Combination** to **ULS-Set B (auto)**
- **Extreme 1D** to **Global**
- **Type of values** to **Overall Unity Check**

Then press **Refresh** to see the results.

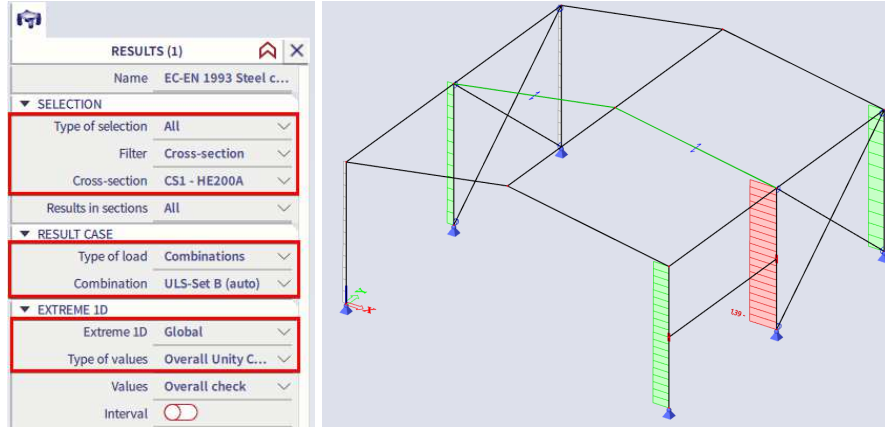

The graphical scene shows that the maximum unity check occurs for one of the middle columns. To understand the reason behind it, you can open the **Report preview** with a detailed representation of the performed steel check. You can find all input data, calculated resistances, code formulas and notices and warnings in the detailed output that usually contains a few A4 pages.

As output you can choose for **Brief**, **Summary** or **Detailed**. For the detailed output you have the option to show both **tables and formulas**. Press **Report preview** to display the output.

**EC-EN 1993 Steel check ULS**  
 Values:  $U_{C_{Overall}}$   
 Linear calculation  
 Combination: ULS-Set B (auto)  
 Coordinate system: Principal  
 Extreme ID: Global  
 Selection: All  
 Filter: Cross-section = CS1 - HE200A

**EN 1993-1-1 Code Check**  
 National annex: Standard EN

**MemberB6** | 0,000 / 5,000 m | HE200A | Rolled | S 235 | ULS-Set B (auto) | 1,39 -

**Combination key**  
 ULS-Set B (auto) / 1.35\*LC1 + 1.35\*LC2 + 1.50\*LC3

**Partial safety factors**

Resistance of cross-sections	Yes	1,00
Resistance to instability	Yes	1,00
Resistance of net sections	Yes	1,25

**Material**

Yield strength	$f_y$	235,0	MPa
Ultimate strength	$f_u$	360,0	MPa

**SECTION CHECKS...**

The critical check is on position 0,000 m

Internal forces	Calculated	Unit
Normal force	$N_{Ed}$	-47,41 kN
Shear force	$V_{Ed}$	-0,06 kN
Shear force	$V_{Ed}$	32,42 kN
Torsion	$T_{Ed}$	0,00 kNm
Bending moment	$M_{y,Ed}$	0,00 kNm
Bending moment	$M_{z,Ed}$	0,00 kNm

**Classification for cross-section design**  
 Classification according to EN 1993-1-1 article 5.5.2  
 Classification of Internal and Outstand parts according to EN 1993-1-1 Table 5.2 Sheet 1 & 2

Id	Type	c [mm]	t [mm]	$\sigma_1$ [MPa]	$\sigma_2$ [MPa]	$\psi$ [-]	$k_{\sigma}$ [-]	$\alpha$ [-]	c/t [-]	Class 1 Limit [-]	Class 2 Limit [-]	Class 3 Limit [-]	Class
1	SO	78,75	10,00	8,81	8,81	1,0	0,4	1,0	7,9	9,0	10,0	14,0	1
3	SO	78,75	10,00	8,81	8,81	1,0	0,4	1,0	7,9	9,0	10,0	14,0	1
4	I	134,00	6,50	8,81	8,80	1,0	1,0	20,6	28,0	34,0	38,0	40,0	1
5	SO	78,75	10,00	8,80	8,80	1,0	0,4	1,0	7,9	9,0	10,0	14,0	1
7	SO	78,75	10,00	8,80	8,80	1,0	0,4	1,0	7,9	9,0	10,0	14,0	1

The cross-section is classified as Class 1  
 Note: The Classification limits have been set according to Semi-Comp+.

**Compression check**  
 According to EN 1993-1-1 article 6.2.4 and formula (6.9)

Cross-section area	A	5,3800e+03	mm <sup>2</sup>
Compression resistance	$N_{Rk}$	1264,30	kN
Unity check		0,04	-

$N_{Rk} = \frac{A \times f_u}{\gamma_{M0}} = \frac{5,3800 \cdot 10^3 \text{ [mm}^2\text{]} \times 235,0 \text{ [MPa]}}{1,00} = 1264,30 \text{ [kN]}$  (EC3-1-1:6.10)

Unity check =  $\frac{|N_{Ed}|}{N_{Rk}} = \frac{|-47,41 \text{ [kN]}|}{1264,30 \text{ [kN]}} = 0,04 \leq 1,00$  (EC3-1-1:6.9)

**Bending moment check for  $M_y$**   
 According to EN 1993-1-1 article 6.3.3 and formula (6.61), (6.62)

This detailed report reveals that the column does not comply with the **Bending and axial compression check** according to EN 1993-1-1 article 6.3.3 and formula (6.61),(6.62). In this particular project; a different cross-section with larger inertia is required.

SCIA Engineer allows for a simple and smooth optimization of the steel section, whether it does not satisfy or whether it is too “heavy” and oversized. The program will automatically propose a cross-section which complies with the unity check.

In the **property panel** under **Actions** you can choose for **Autodesign** in order to optimize the cross-sections.



*Note: steel optimization works with cross-sections, not particular members. Therefore once the cross-section is changed, all members with that profile are changes as well. Therefore in the property panel the **Filter** should be set to **Cross-section** when you use the Autodesign action.*

In the dialogue press [**Search for optimal**] and the software will search within the profile library for a new cross-section and stops with the first one that satisfies the defined **maximal check** (1.00 in our example).

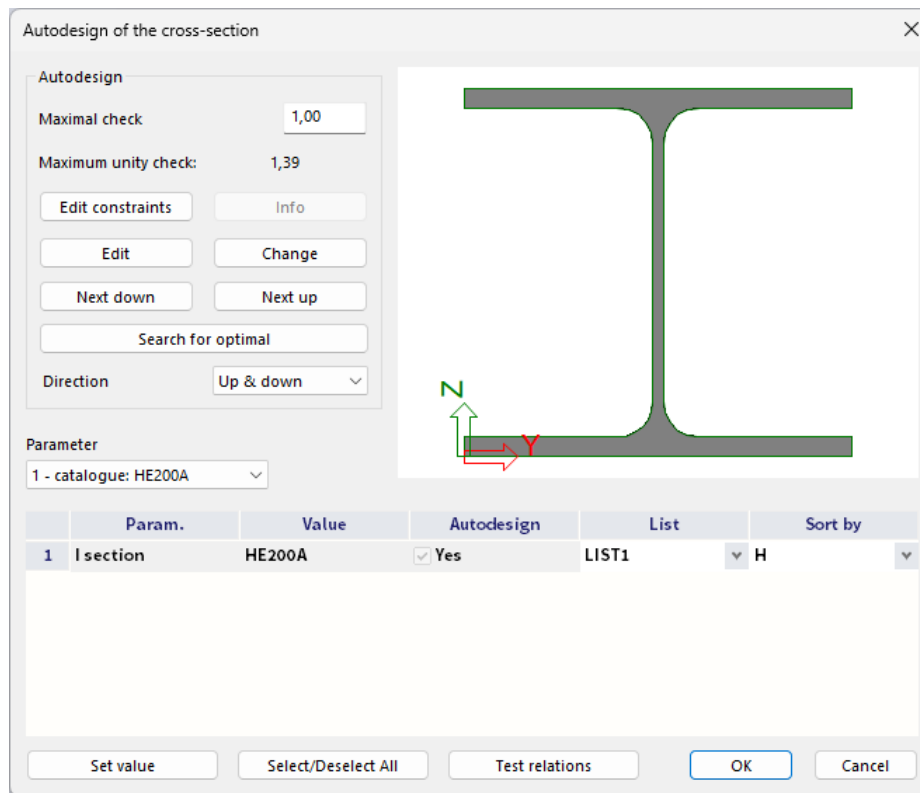

*Note: it is also possible to search in a list. Define lists via **Main menu > Libraries > Structure and analysis > Cross section list**.*

The software finds a cross-section HE240A with a check of 0.79.

After confirming with [**OK**], all members with the same cross-section will be changed.

*Note: the project must be recalculated after the optimization. The changed cross-section modifies the self weight of the structure as well as the stiffness of the whole model, which will lead to a different distribution of the internal forces. This specifically means that, after optimization and recalculation of the structure, the concerned cross-section could possibly reveal inappropriate. In that case, you must re-execute the optimization in order to find a solution in an iterative manner.*

Whole structure can be optimized using the steps above again for another cross-section (CS2, CS3,...). However, the procedure was described and repeating it for all the members is not an intention of this tutorial.

### 7.2.2. SLS check

You can perform a steel SLS (Serviceability Limit State) check via **Main menu > Steel members > SLS check** or via the process toolbar.



The properties are set similarly as for the ULS check.

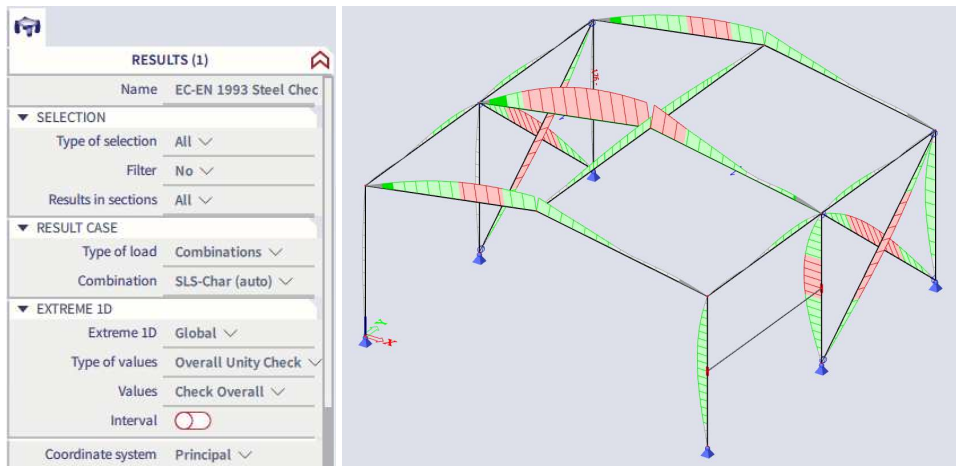

With this check the relative deformations are compared with the deflection limits, as defined in the steel settings or via the system lengths and buckling settings. When the check is exceeded, you can check if the deflection limits are set properly or you need to change the cross-section of the elements. An SLS autodesign command is not available in SCIA Engineer.



## Chapter 8: Steel connections

As steel connections both frame strong-axis and frame weak-axis connections can be modelled, as well as pinned grid connections and hollow section joints.

In this tutorial, as an example a frame strong-axis connection will be inserted between a column and a roof girder.

### 8.1. Structural model

Go to **Main menu > File > Project settings** and activate **Structural model** (and **Steel Connections** for adding the connection later on) in the **Functionality** tab.

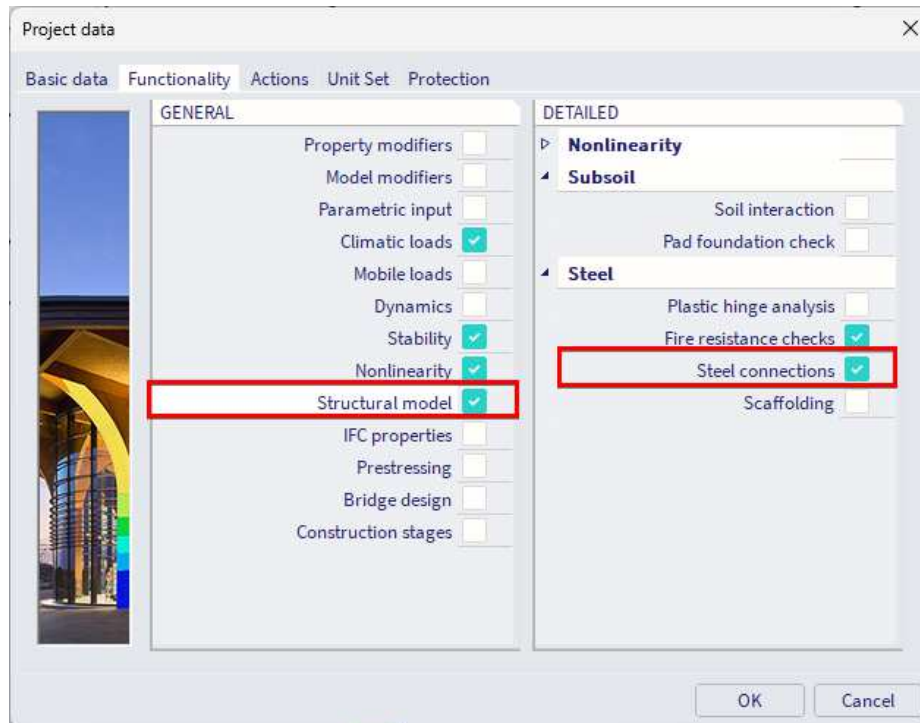

In the analysis model, the members arrive in the same node. But in practice the girder is cut for instance at the column flange or vice versa. You can indicate this through the structural model.

Now go to **Main menu > View > Visualization > Generate structural model**.

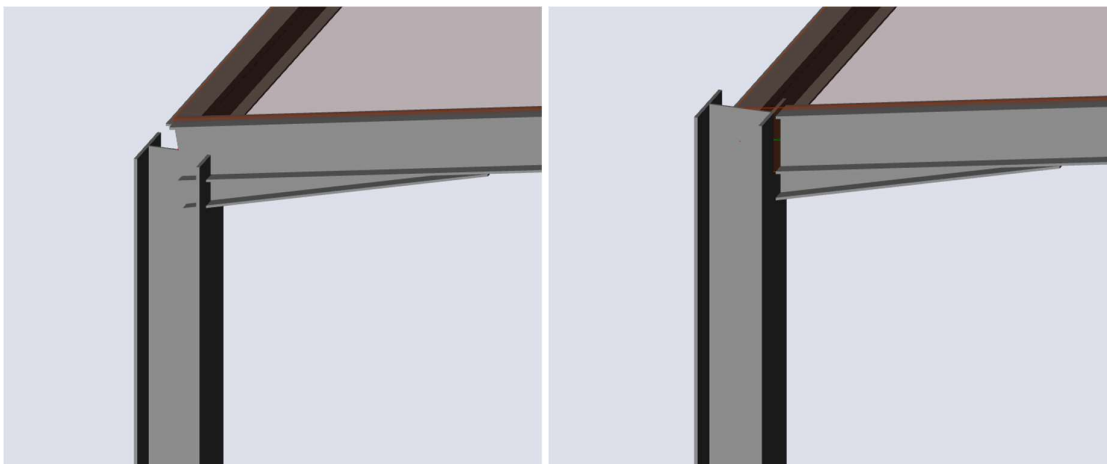

The structural model will show you the real appearance of the structure, which is important when we want to create connections.

*Note: the structural model uses priorities of 1D members. The element with the highest priority value has priority over an element with a lower priority. By default, an element of the Column type has a higher priority (100) than an element of the Beam (80) type. Therefore, the beam is cut at the column flange and the column is a bit extended to be aligned with the top flange level of the beam.*

If needed you can change the **Priority value** property of the members (via the property panel), what will influence which member(s) will be trimmed and which member(s) will be extended.

Steel connections are always based on the structural model. If the column continues, a connection with end-plate on the roof beam is obtained. If the roof beam continues, a connection with end-plate on the column is obtained.

## 8.2. Steel connection

In the **input panel** go to **workstation Steel** and choose **Frame strong-axis**. You can find the command as well in the **workstation Steel** of the **process toolbar**.

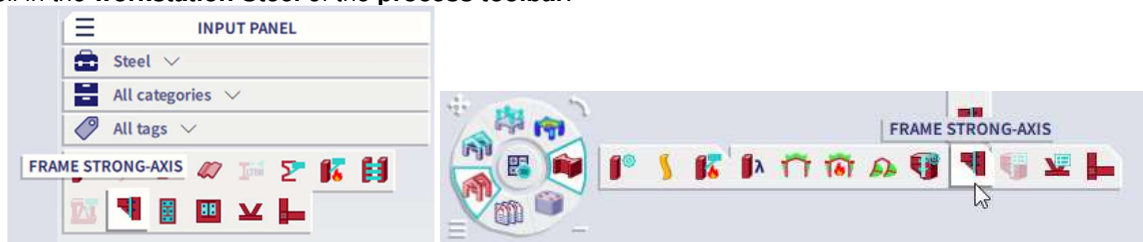

Select the node where you want to create the connection. Now indicate the members between which the connection should be established. The program automatically selects (and highlights) all members arriving in the node. As the connection should be inserted between the column and the roof beam, deselect the girder while pressing the **<Ctrl>** or **<Shift>** button.

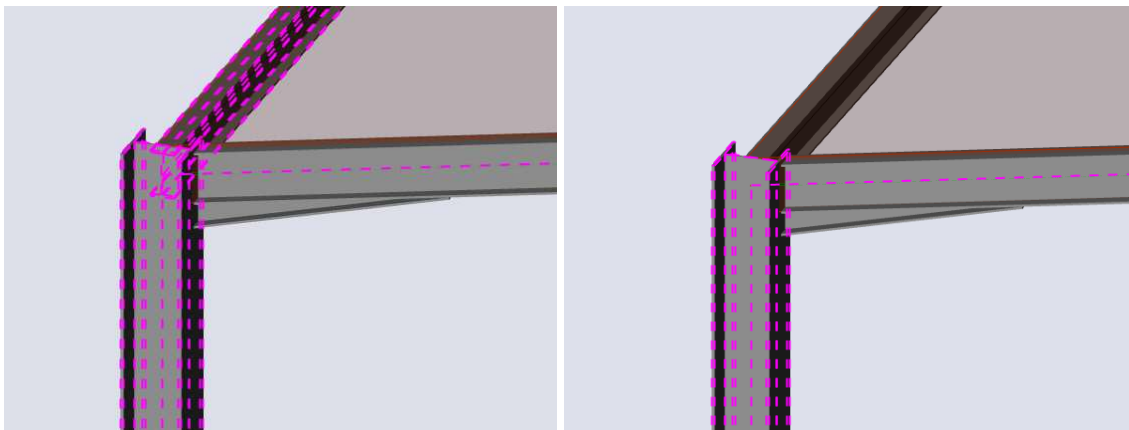

Confirm with **<Esc>**.

The connection is inserted (by the mean of a flag which contains **Conn** and the **[node name]**) and the properties, including components, are displayed in the **property panel**.



In the **property panel** you can set already the **Type of loads** to **Combinations** and **Combinations** to **ULS-Set B (auto)**. Now, the components of the connection can be activated. Activate **End-plate** and click on the **Manage** icon. The end-plate is added and immediately displayed in the graphical scene. In the dialogue you can change parameters of the end-plate and confirm with **[OK]**.

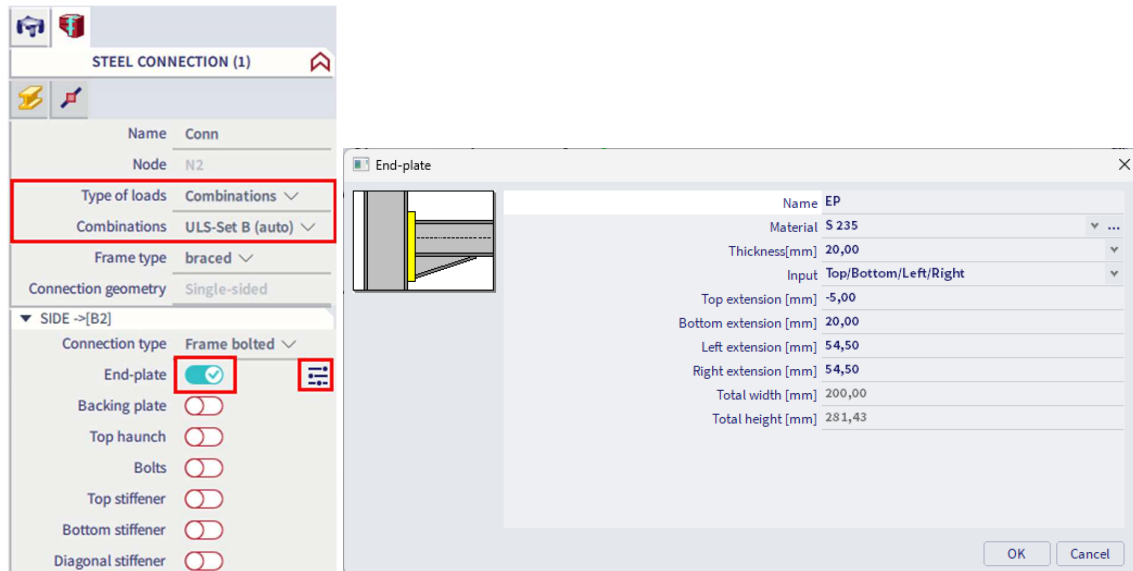

Activate **Bolts** and click on the **Manage** icon. The bolts are automatically displayed in the graphical scene. In the dialogue you can select bolt assembly **M20 - 8.8**. A window informs you that the bolt assembly was changed. When confirming with **[Yes]** the bolts positions, intermediate distances, edge distances, ... are automatically adapted to the new bolt assembly. Furthermore in the dialogue you can activate or deactivate bolt-rows and set the position with the property **Location**.

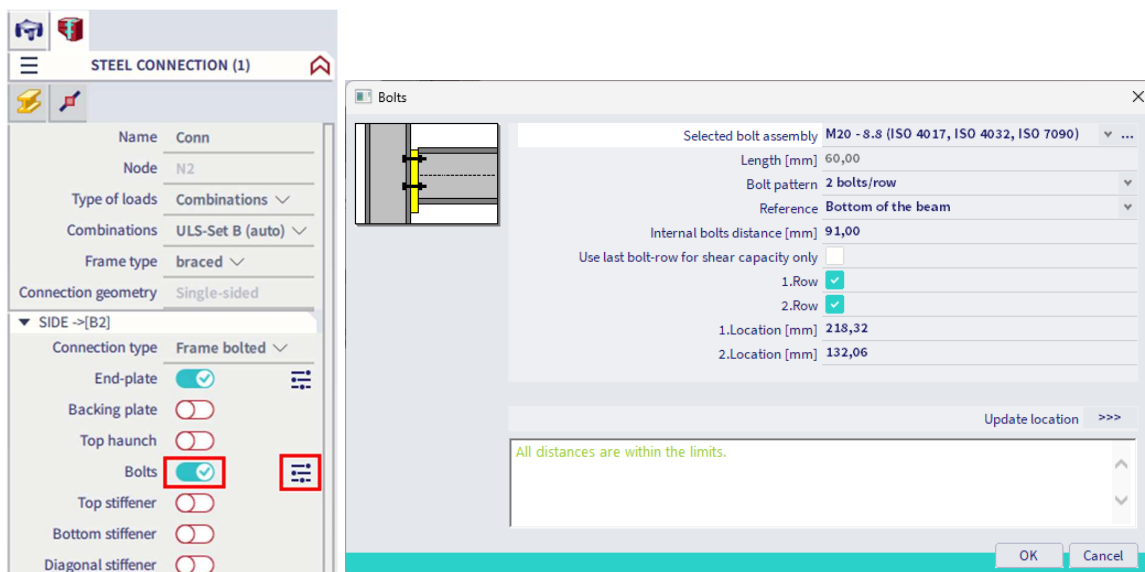

To complete the connection, activate the components **Top stiffener** and **Bottom stiffener**. Also for these components, you could change the properties via the **Manage** icons.

The connection is now displayed in the same colour as the model. To change this view, use the **View settings** dialogue and activate the options **Welds** and **Coloured** in the **Connections** tab.

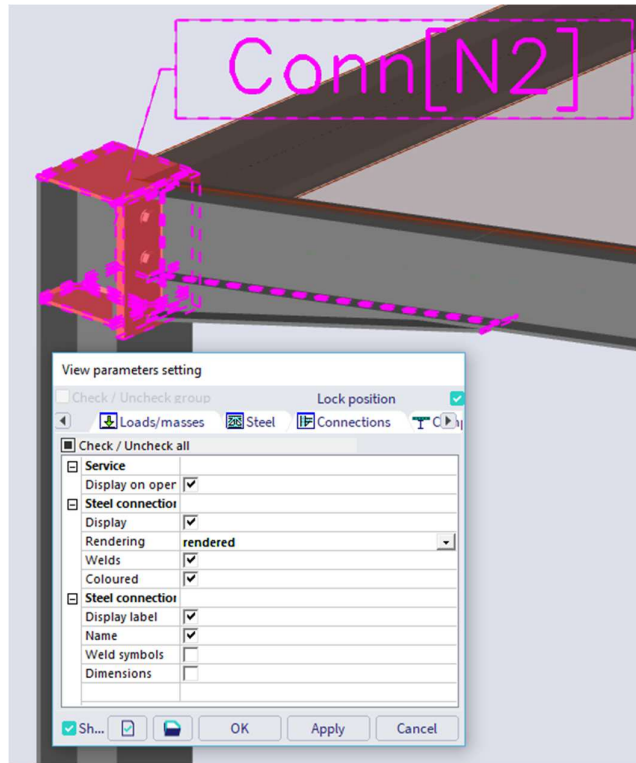

The connection is now completely modelled and you can open the results.

Select the connection and click on the **Action Open Preview** to display the results in **Report Preview**.

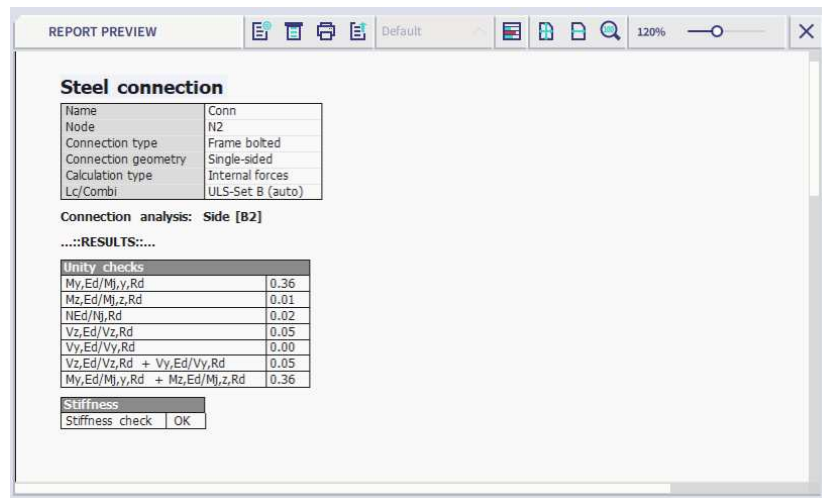

You can set the **Output** as **Brief**, **Summary** or **Detailed**. The summary output shows the internal forces, design resistances, results of unity checks and moment-rotation diagrams.

**Notes:**

- Detailed output with all intermediate calculations can be also displayed if necessary. It covers many A4 pages for just one connection to enable hand verification of the provided results.
- Connections are additional data, i.e. a connection can be copied to other nodes.

## Chapter 9: Report

In this final part of the tutorial, we will explain how to make a report of the assumptions, calculation and design.

### 9.1. Engineering report

You can select the **Report** command via **Main menu > Tools > Report** or with the icon in the **workstation Reports**.



Because no report was created before, Report\_1 directly appears as a new application. This application is in a certain way independent of the SCIA Engineer application. That is visible as well in the Windows main bar by a separate icon.



Click the **Insert** button in the ribbon to start inputting items in the report navigator. A window with **New items** appears just below the insert icon:

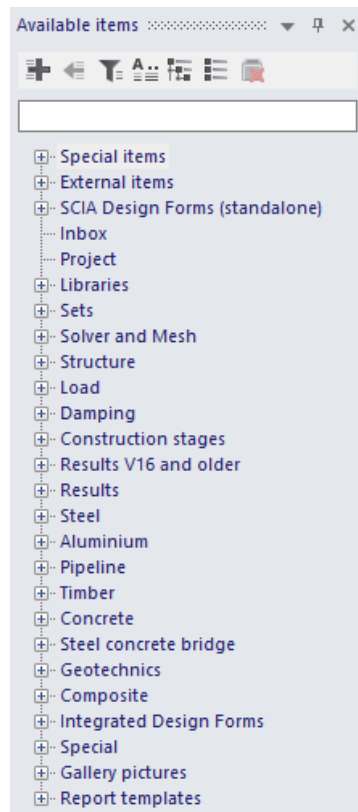
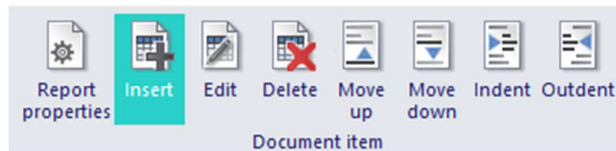

Using this window, various data can be added to the report.

- Open the **Special items** group to add **Page Format, Header / Footer** and **Table of contents**. Double-click on the item or hit the **+** button to add the item to the **Navigator**.
- Create a chapters Geometry, Loads and Results with the item **Chapter** from the **Special items** group.
- Open the **Libraries** group and select **Materials and Cross-sections**.
- Open the **Structure** group to add **Nodes, Members, Load panels, Haunches, Hinges** and **Nodal supports**.

Drag the items with the mouse to change their order or use the icons in the **Document item** part of the ribbon.

You can directly see these items in the **Navigator** and on the paper preview as well:

The screenshot displays the SCIA Engineer software interface. On the left is the **Navigator** pane, which is organized into several groups: **Page format** (Header / Footer, Table of contents), **Geometry (Chapter)** (Materials, Cross-sections, Nodes, Members, Load panels, Haunches, Hinges, Nodal supports), **Loads (Chapter)** (Load cases, Combinations), and **Available items** (Special items, External items, SCIA Design Forms, In-box, Project, Libraries, Sets, Solver and Mesh, Structure, Load, Damping, Construction stages, Results V16 and older, Results, Steel, Aluminium, Pipeline, Timber, Concrete, Steel concrete bridge, Geotechnics, Composite, Integrated Design Forms, Special, Gallery pictures, Report templates). On the right is a preview of an engineering report. The report header includes the SCIAENGINEER logo and project details: Part: -, Author: -, Date: 23.05.2016, National code: EC - EN, National annex: Standard EN, Licence name: Unknown, Licence number: 660045. The report content includes a **1. Table of contents** section listing items like Table of contents, Geometry, Materials, Cross-sections, Nodes, Members, Load panels, Haunches, Hinges, Nodal supports, Loads, and Load cases with their respective page numbers. Below this is a **2.1. Materials** section for **SteelEC3**, which includes a table of material properties.

Name	$\rho$ [kg/m <sup>3</sup> ]	$E_{mod}$ [MPa]	$\mu$ [m/mk]	Lower limit [mm]	Upper limit [mm]	$F_y$ [MPa]	$F_u$ [MPa]	Colour
S 235	7850.0	2.1000e+05	0.3	0	40	235.0	360.0	
		8.0769e+04	0.00	40	80	215.0	360.0	

### 9.1.1. Adding images to the report

Any picture from SCIA Engineer application can be set to Engineering Report. Either as printscreen (that is unchanged forever) or as live picture (that can be regenerated and is always up-to date).

Prepare any scene in the 3D modelling window, for example the analytical model with loads. You can use the icons of the **view bar** to hide surfaces, render and show loads:

You can immediately add a live image via the **Live image to report** command via **Main menu > Tools > Sent > Live image to report** or with the icon in the **workstation Reports**.

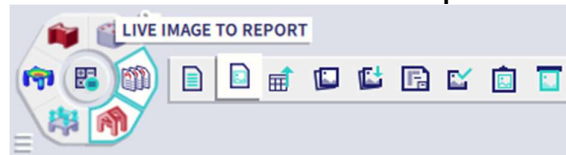

A properties dialogue for the image is opened. Here you can arrange the picture caption, scale, size, ... Use the button [Two at page] at the top ribbon, tick the option **Automatic scale to fit size** on and click on button [Insert & Close] from the tab **into selected report**.

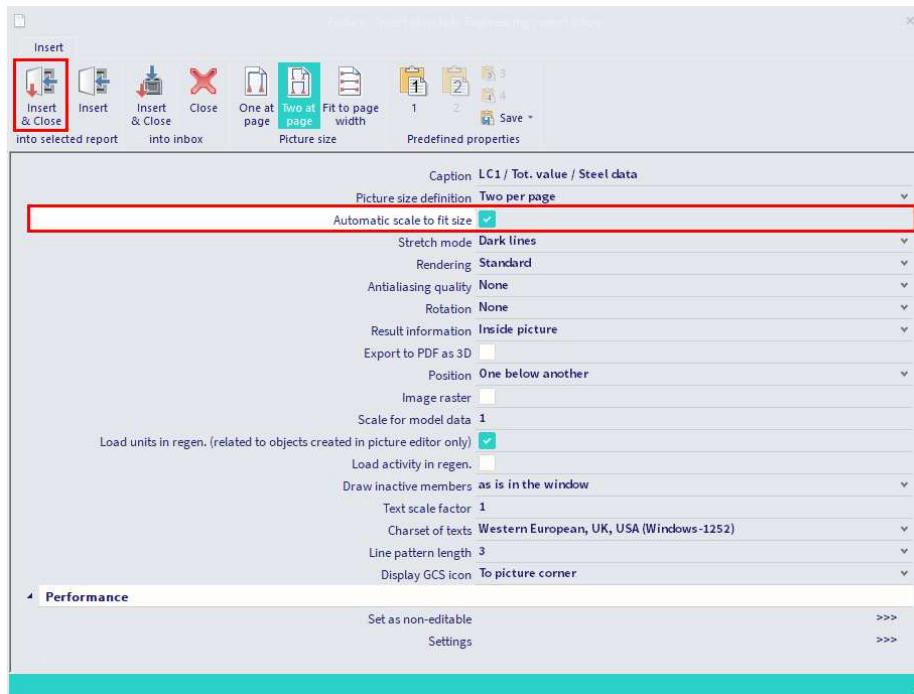

In the report you can indent this item under the item Load cases. When regenerating this item, an image will automatically be generated for each load case (in case that **Selection type** is set to **All** in the properties of the load cases item), based on the image that you have added before.



3.1.2. Load cases - LC2

Name	Description	Action type	Load group
LC2	Other permanent loads	Permanent	LG1

#### 3.1.2.1. Picture

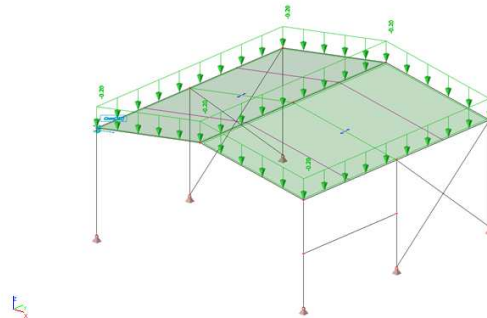

### 9.1.2. Displaying results

Go to **Available items**, open the **Results** group and click on **1D Internal forces**.

In the navigator click on 1D Internal forces. The red exclamation mark both in the navigator and the preview indicates that the presented values are not up-to-date.

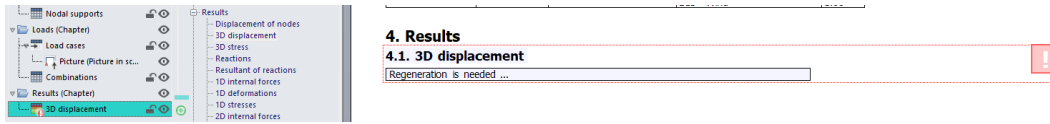

In the **properties window** the setting of this table is displayed. Parameters for displaying the results in the Engineering Report are configured in the same way as the parameters for viewing the results in the SCIA Engineer application:

- **Selection type** is set to **All**
- **Type of load** is set to **Combinations** and the **Combination** to **ULS-Set B (auto)**
- **Extreme 1D** field is set to **Global**

Choose **Regenerate selected** (or **Regenerate outdated** in case that you want to regenerate all outdated item in the whole report) in the top ribbon to display the table in accordance with the predefined options.

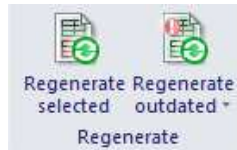

The red exclamation mark disappears.

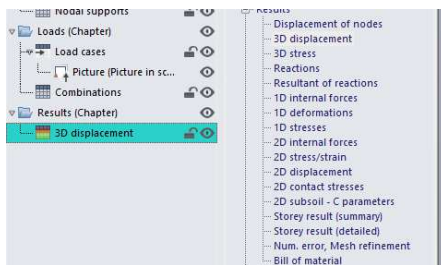

#### 4. Results

##### 4.1. 3D displacement

Linear calculation  
 Load case: LC1  
 Selection: All  
 Location: In nodes avg. on macro. System: LCS mesh element  
**Results on 1D member:**  
 Extreme 1D: Global

Name	dx [m]	Fibre	Case	u <sub>x</sub> [mm]	u <sub>y</sub> [mm]	u <sub>z</sub> [mm]	φ <sub>x</sub> [mrad]	φ <sub>y</sub> [mrad]	φ <sub>z</sub> [mrad]	U <sub>total</sub> [mm]
B5	0.000	8	LC1	0.0	0.0	0.0	0.0	-0.6	0.0	<b>0.0</b>
B431	4.111	3	LC1	-0.1	-52.1	-13.1	-0.1	-0.5	1.6	<b>53.7</b>

A list of items for this projectId look like this:

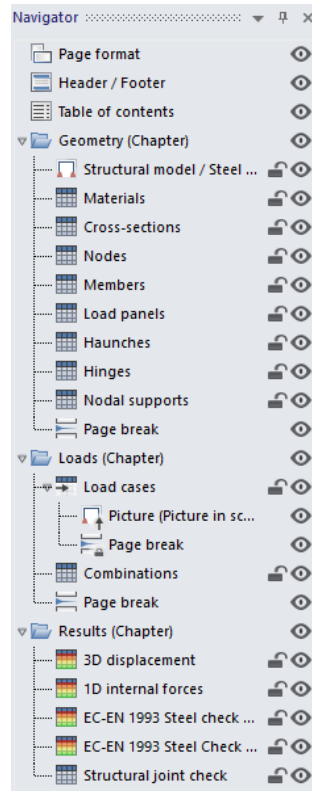

### 9.1.3. Printing or exporting the report

Once the report is completed you can print it or export into various formats (e.g. PDF, txt, RTF, Html, Excel) by clicking the top left button of the window:

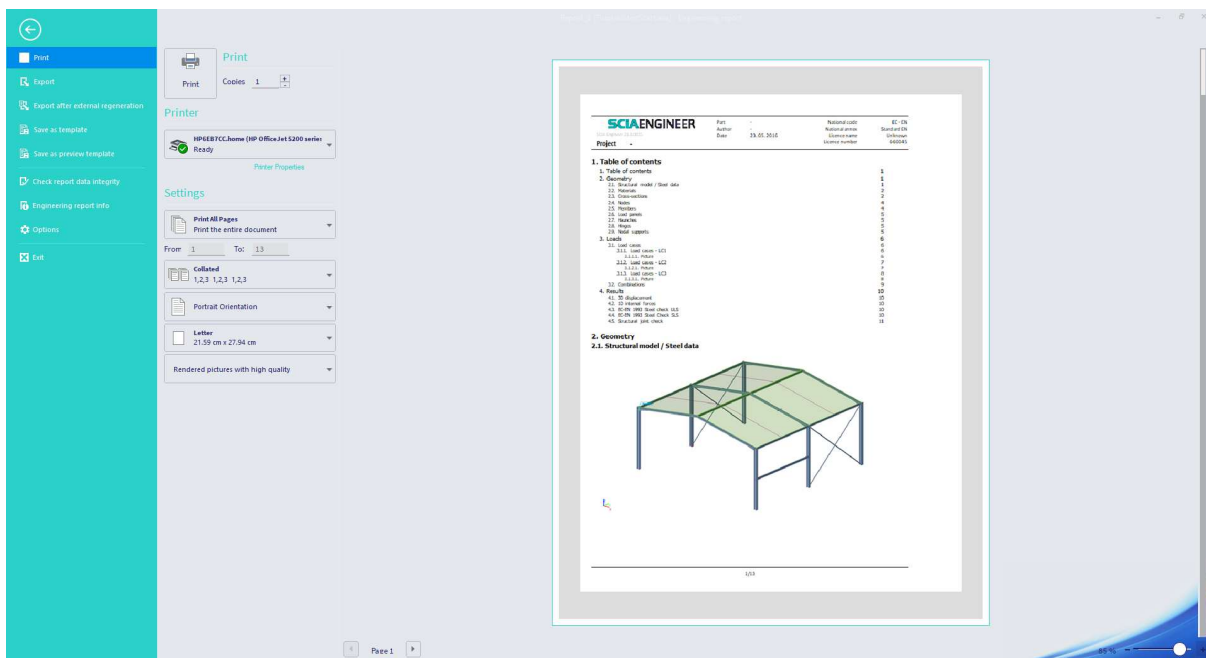

There is also the option **Save as template**, so you can reuse the items from this report for other projects.